



Quick Installation Guide

X1-Hybrid 3.0 kW-7.5 kW

II

Tool Preparation

I

Packing List

Note:
 ● Accessories marked with "*" indicates that, the M-series inverter is equipped with 3 pieces for Australia and 2 pieces for other countries, and the D-series inverter is equipped with 4 pieces for Australia and 3 pieces for other countries.
 ● Accessories marked with "*" indicate that they are included in the D-series inverter, but not the M-series inverter.

III

Mounting Steps

Note: Regarding the installation of M-series inverter, please refer to the X1-Matebox Quick Installation Guide.

a) Draw drilling holes as per the bracket's hole locations by a marker, and ensure that the two top holes lie on the same straight line by leveling instrument.

b) Drill holes at marked spots at depth of 80 mm.

c) Insert expansion bolt into the holes, use rubber hammer to knock the expansion screw bolt into the wall.

d) The bracket is aligned with the screw uses the outer hexagonal wrench to screw the tapping screw until the expansion bolt "bang" is heard.

e) Hang the buckle on the inverter to the corresponding position of the backplane.

f) Use the inner hexagonal wrench to tighten the inner hexagonal screw on the right side of the inverter.

IV

PV Connection

The PV port wiring of M-series inverter has been completed on X1-Matebox, the D-series needs to be wired according to the following steps.

Step 1. Turn off the DC switch, connect the PV module, prepare a 4 mm² PV cable, and find the PV (+) terminal and PV (-) terminal in the package.

Step 2. Use a wire stripper to strip the 7 mm insulation layer of the wire end.

Step 3. The PV connector is divided into 2 parts, to the plug and the fastening head. Pass the cable through the fastening head and the alignment plug. Note that the red and black lines correspond to different pairs of plugs. Finally, force the cable into the plug and hear a "click" to indicate that the connection is completed.

Step 4. Tighten the fastening head and insert into the corresponding positive and negative (PV-/PV+) parts of the inverter.

V

Grid and EPS(Off-grid) Connection

Diagram A: Neutral line and PE line are separated from each other, and the common load is connected to the EPS(Off-grid) port; (For most countries)

Diagram B: Neutral line and PE line are separated from each other, all loads connect to the EPS(Off-grid) port; (For most countries)

Diagram C: Neutral line and PE line are combined together, and the common load is connected to the EPS(Off-grid) port; (Apply to Australia)

Diagram D: Neutral line and PE line are combined together, all loads connect to the EPS(Off-grid) port; (Apply to Australia)

VI

Battery Connection

Battery connection diagram:

Battery port connection line of the M series inverter is on the X1-Matebox, just connect it. It is necessary to wire the D series according to the following steps.

Step 1. Turn off the DC switch, connect the BAT module, prepare a 6 mm² BAT cable, and find the BAT (+) terminal and BAT (-) terminal in the package.

Step 2. Use a wire stripper to strip the 7 mm insulation layer of the wire end.

Step 3. The BAT joint is divided into 2 parts, to the plug and the fastening head. Pass the cable through the fastening head and the alignment plug. Note that the red and black lines correspond to different pairs of plugs. Finally, force the cable into the plug and hear a "click" to indicate that the connection is completed.

Step 4. Tighten the fastening head and insert into the corresponding positive and negative (BAT-/BAT+) parts of the inverter.

Note: BAT port (Blue one) not PV port (Black one). Note: The positive and negative wires of the battery are not allowed to be reversed!

Notice: After the BMS communication between the battery and the inverter is finished, the battery will work normally.

The Grid and EPS(Off-grid) ports of M series inverter have been connected, and the D series needs to be wired according to the following steps.

Step 1. Prepare a Grid cable (three-core wire) and an EPS(Off-grid) cable (two-core wire), and then find the European terminal and waterproof shield in the accessory bag.

Grid Cable and Micro-breaker recommended						EPS(Off-grid) Cable and Micro-breaker recommended					
Model	X1-Hybrid-3.0-D	X1-Hybrid-3.7-D	X1-Hybrid-5.0-D	X1-Hybrid-6.0-D	X1-Hybrid-7.5-D	Model	X1-Hybrid-3.0-M	X1-Hybrid-3.7-M	X1-Hybrid-5.0-M	X1-Hybrid-6.0-M	X1-Hybrid-7.5-M
Cable (copper)	4-6 mm²	6-8 mm²	8-10 mm²	8-10 mm²	8-10 mm²	Cable (copper)	3-4 mm²	3-4 mm²	4-6 mm²	4-6 mm²	6-8 mm²
Micro-Breaker	32 A	40 A	50 A	50 A	50 A	Micro-Breaker	25 A	25 A	32 A	32 A	40 A

Step 2: The Grid and EPS(Off-grid) cables go through the corresponding Grid and EPS(Off-grid) ports of the waterproof shield. Remove the 12 mm insulation layer at the end of the wire. Insert the European-style terminals respectively, and make sure that the stripped ends are inserted into the European-style terminal, and finally use crimping pliers to press tightly.

VII Communication Connection (BMS/Meter/CT/DRM/COM)

Electric meter connection diagram

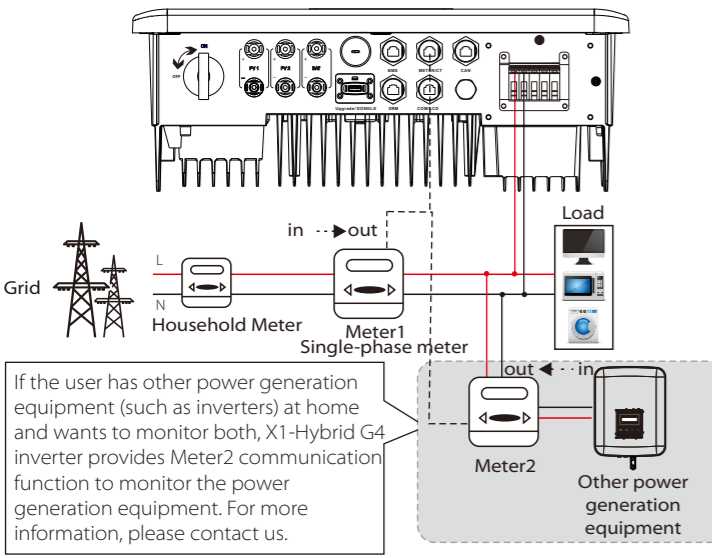

CT connection diagram

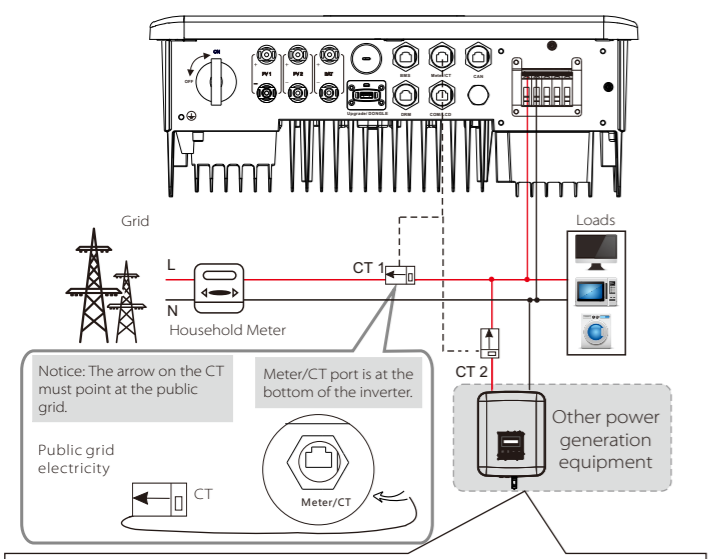

LCD settings

To select CT, you need to enter Use setting, then enter CT or Meter Setting.

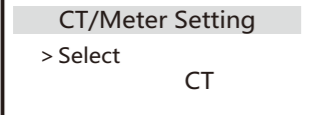

Meter /CT PIN is defined as follows

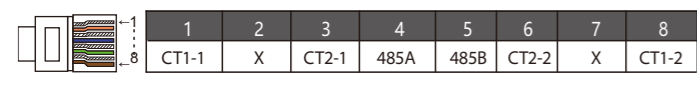

Notice: Only one of the Meter and CT connections can be selected. Meter cable goes to pin terminal 4 and 5; CT cable goes to pin terminal 1 and 8; reserve CT cable goes to pin terminal 3 and 6. If you need this feature, please contact us for assistance.

1) To connect the Communication line of the CT line, the lines need to be made on both sides, connecting the RJ45 terminal on one side and the Communication line Adapter on the other.

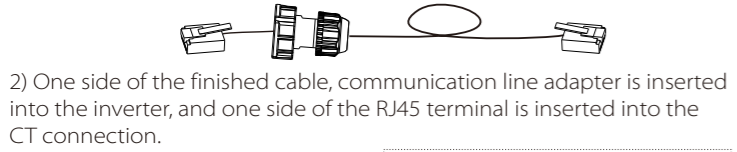

COM Communication

External communication equipment controls the inverter:

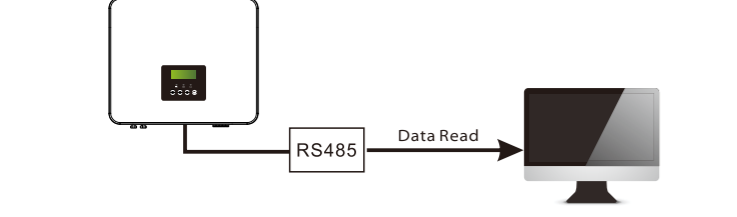

Inverter communication control external equipment:

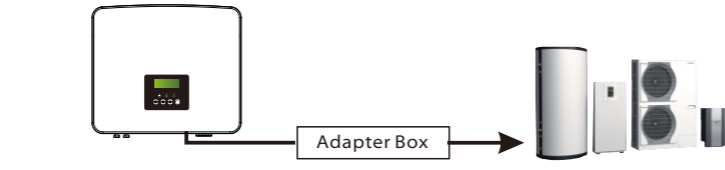

COM PIN Definition

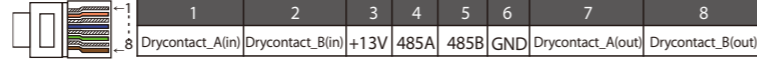

Notice: Customers can communicate or control the inverter and external devices through the COM interface. Professional users can use pins 4 and 5 to realize data acquisition and external control functions. The communication protocol is Modbus RTU. For details, please contact us. If the user wants to use the inverter dry contact to control external equipment (such as a heat pump), it can be used with our Adapter Box. For details, please refer to the Quick Installation Manual of the Adapter Box.

The BMS pin is defined as follows

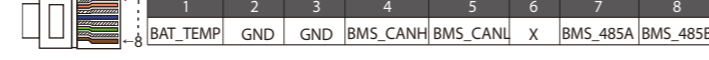

Notice: The BMS port on the inverter is the communication port for connecting the battery. The communication port on the lithium battery must be consistent with the definition of pins 4, 5, 7, and 8 above.

The DRM pin is defined as follows

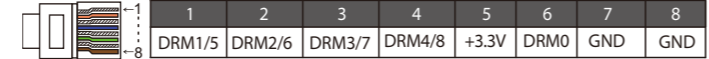

Notice: For AS4777 DRM function, currently only PIN6 (DRM0) and PIN1 (DRM1/5) are functional, other PIN functions are under development.

Communication Connection Steps

Step 1. Prepare a communication cable, and then find the communication adapter in the accessory bag.

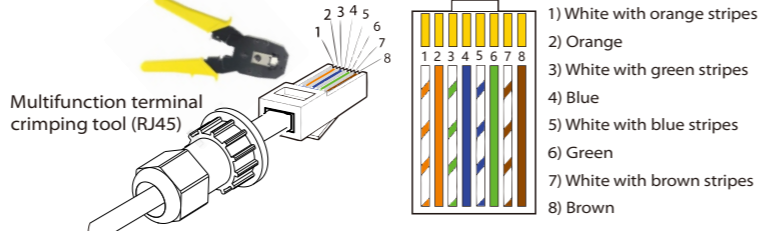
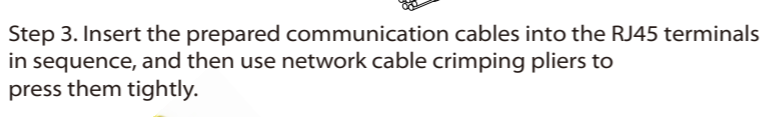
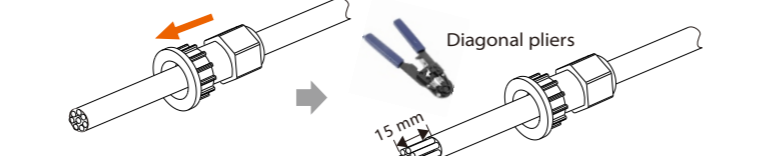
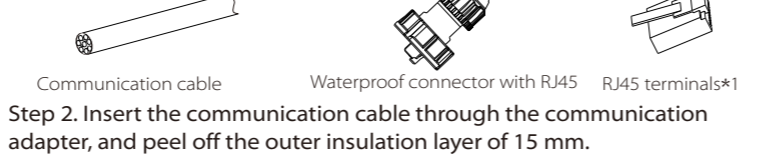

Step 5. Finally, find the corresponding BMS / Meter / CT/CAN / DRM / COM / LCD ports on the inverter and insert the communication cable into the corresponding ports.

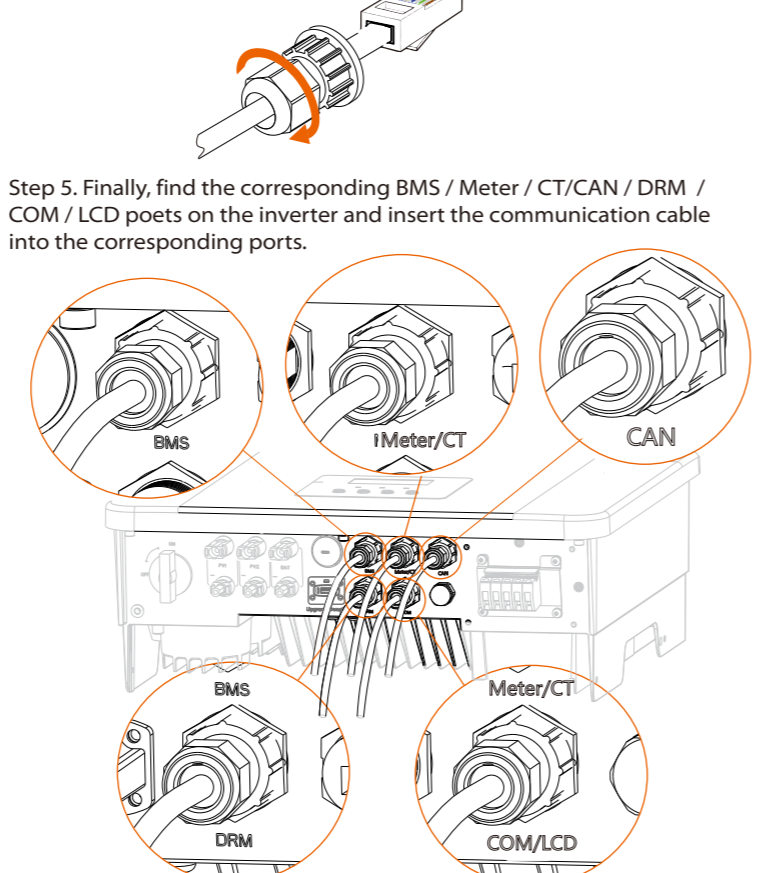

VIII Grounding Connection (mandatory)

The ground wire port of M series inverter has been connected, and the D series needs to be wired according to the following steps.

Step 1. Prepare a one-core cable (4 mm²), and then find the ground terminal in the accessories.

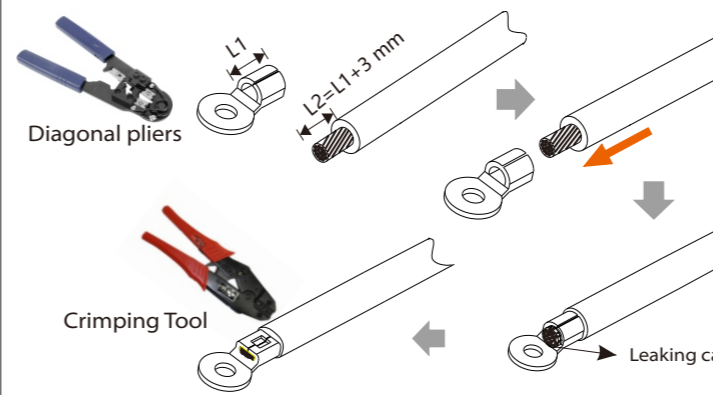
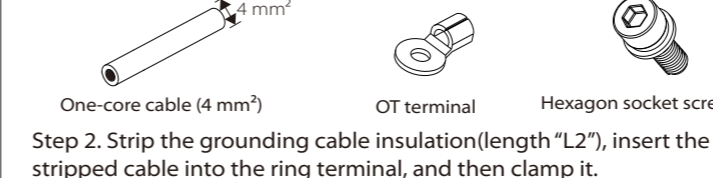

Step 3. Find the ground connection port on the inverter, and screw the ground wire on the inverter with an M5 Allen key.

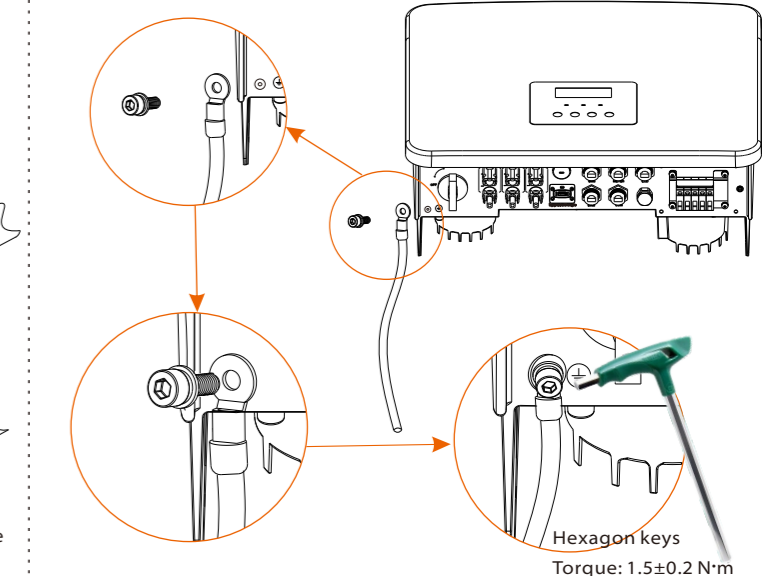

IX Monitoring Operation

DONGLE connection diagram

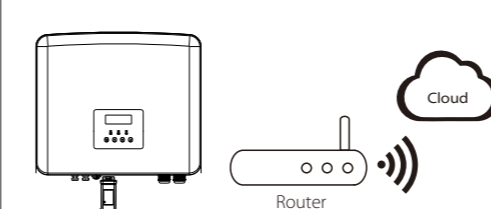

Step 2. Plug WiFi Dongle into the DONGLE port.

Please check the WiFi Dongle user manual/LAN Dongle user manual/4G user manual for more details.

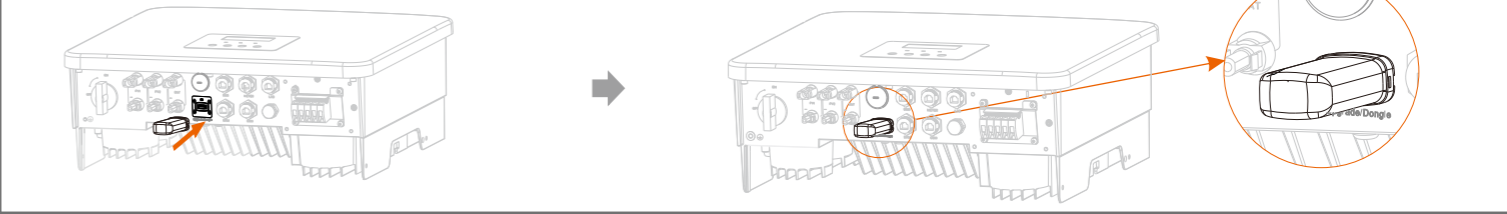

Wireless monitoring accessories connection steps:

Step 1. First find the DONGLE port of the inverter.

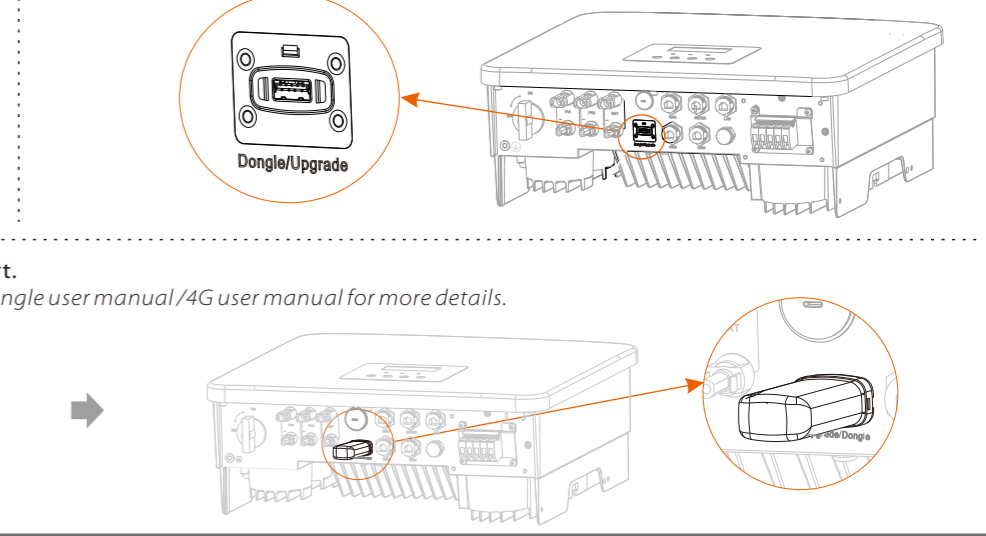

X Start Guide

1. Set date time Date&time 2017-06-06 10:19	2. Set language Language English Deutsch Italian	6*. Set work mode There are 4 work modes for choice: Self use/Feed-in Priority/ Backup Mode/ EPS.										
3. Set the safety standard Safety Country >VDE0126	4. CT/Meter Setting CT >Meter	<table border="1"> <thead> <tr> <th>Name</th> <th>Description</th> </tr> </thead> <tbody> <tr> <td>Self Use</td> <td>The self-use mode is suitable for areas with low feed-in subsidies and high electricity prices. ① When the power of PV is sufficient Active Charge or Discharge time period: PV will power the loads firstly, and surplus power will charge to the battery. If the battery is fully charged, then sell the surplus power to the grid; (The inverter will limit the output if Feed-in limit or zero feed-in is needed). (PV > Load, PV + Grid → Load) ② When the power of PV is insufficient Active Charge time period: PV will power the loads firstly, the remaining power will be taken from the grid, the battery will not discharge at this time. (PV + Load, PV + Grid → Load) Active Discharge time period: PV+BAT will power the loads together. If the power is still not enough, the remaining power will be taken from the grid. (PV < Load, PV + Battery + Grid → Load) ③ Without PV power Active Charge time period: The grid supplies the loads and also can charge the battery. (PV=0, Grid → Load + Battery) Active Discharge time period: First, PV supply power to the load, then charge the battery to the set capacity, and then sell the power to the grid. If the local grid company limits the grid-connected power of the inverter, the excess energy continues to charge the battery. (PV > Load, PV + Load → Battery) Active Discharge time period: PV will power the loads firstly, and surplus power will feed-in to the grid. (PV < Load, PV → Load + Grid)</td> </tr> <tr> <td>Feed-in priority</td> <td>① When the power of PV is sufficient Active Charge time period: PV will power the loads firstly, the remaining power will be taken from the grid. The battery will not discharge. (PV > Load, PV + Grid → Load) Discharge time period: PV+BAT will power the loads together. If the power is still not enough, the remaining power will be taken from the grid. (PV < Load, PV + Battery + Grid → Load) ② When the power of PV is insufficient Active Charge time period: The grid will power the home loads and also charge the battery. (PV=0, Grid → Load + Battery) Active Discharge time period: The battery will power the home loads firstly. If the battery power is not enough, the remaining power will be taken from the grid. The inverter will enter into the standby state. (PV=0, Battery+Grid → Load) Battery min SOC can be set: 10%-100%; Charge battery to min SOC can be set: 10%-100%.</td> </tr> <tr> <td>Backup mode</td> <td>The back-up mode is suitable for areas with frequent power outages. Same working logic with "Self-use" mode. This mode will maintain the battery capacity at a relatively high level, to ensure that the emergency loads can be used when the grid is off. Customers no need to worry about the battery capacity. Battery min SOC can be set: 30%-100%; Charge battery to min SOC can be set: 30%-100%. In case of power failure, the system will power EPS loads through PV and battery. (Battery must be installed, and EPS loads shall not exceed battery's max. output power) ① When the power of PV is sufficient PV will power the loads firstly, and surplus power will charge to the battery. (PV > Load, PV → Load + Battery) ② When the power of PV is insufficient The remaining power will be taken from the battery. (PV < Load, PV → Load)</td> </tr> <tr> <td>EPS Off-grid</td> <td>The battery will power the emergency loads until the battery reached the min SOC, then the inverter will enter an idle mode. (PV=0, Battery → Load) EPS(Off-grid) SOC-min condition is adjustable within the range of 10%-25%.</td> </tr> </tbody> </table>	Name	Description	Self Use	The self-use mode is suitable for areas with low feed-in subsidies and high electricity prices. ① When the power of PV is sufficient Active Charge or Discharge time period: PV will power the loads firstly, and surplus power will charge to the battery. If the battery is fully charged, then sell the surplus power to the grid; (The inverter will limit the output if Feed-in limit or zero feed-in is needed). (PV > Load, PV + Grid → Load) ② When the power of PV is insufficient Active Charge time period: PV will power the loads firstly, the remaining power will be taken from the grid, the battery will not discharge at this time. (PV + Load, PV + Grid → Load) Active Discharge time period: PV+BAT will power the loads together. If the power is still not enough, the remaining power will be taken from the grid. (PV < Load, PV + Battery + Grid → Load) ③ Without PV power Active Charge time period: The grid supplies the loads and also can charge the battery. (PV=0, Grid → Load + Battery) Active Discharge time period: First, PV supply power to the load, then charge the battery to the set capacity, and then sell the power to the grid. If the local grid company limits the grid-connected power of the inverter, the excess energy continues to charge the battery. (PV > Load, PV + Load → Battery) Active Discharge time period: PV will power the loads firstly, and surplus power will feed-in to the grid. (PV < Load, PV → Load + Grid)	Feed-in priority	① When the power of PV is sufficient Active Charge time period: PV will power the loads firstly, the remaining power will be taken from the grid. The battery will not discharge. (PV > Load, PV + Grid → Load) Discharge time period: PV+BAT will power the loads together. If the power is still not enough, the remaining power will be taken from the grid. (PV < Load, PV + Battery + Grid → Load) ② When the power of PV is insufficient Active Charge time period: The grid will power the home loads and also charge the battery. (PV=0, Grid → Load + Battery) Active Discharge time period: The battery will power the home loads firstly. If the battery power is not enough, the remaining power will be taken from the grid. The inverter will enter into the standby state. (PV=0, Battery+Grid → Load) Battery min SOC can be set: 10%-100%; Charge battery to min SOC can be set: 10%-100%.	Backup mode	The back-up mode is suitable for areas with frequent power outages. Same working logic with "Self-use" mode. This mode will maintain the battery capacity at a relatively high level, to ensure that the emergency loads can be used when the grid is off. Customers no need to worry about the battery capacity. Battery min SOC can be set: 30%-100%; Charge battery to min SOC can be set: 30%-100%. In case of power failure, the system will power EPS loads through PV and battery. (Battery must be installed, and EPS loads shall not exceed battery's max. output power) ① When the power of PV is sufficient PV will power the loads firstly, and surplus power will charge to the battery. (PV > Load, PV → Load + Battery) ② When the power of PV is insufficient The remaining power will be taken from the battery. (PV < Load, PV → Load)	EPS Off-grid	The battery will power the emergency loads until the battery reached the min SOC, then the inverter will enter an idle mode. (PV=0, Battery → Load) EPS(Off-grid) SOC-min condition is adjustable within the range of 10%-25%.
Name	Description											
Self Use	The self-use mode is suitable for areas with low feed-in subsidies and high electricity prices. ① When the power of PV is sufficient Active Charge or Discharge time period: PV will power the loads firstly, and surplus power will charge to the battery. If the battery is fully charged, then sell the surplus power to the grid; (The inverter will limit the output if Feed-in limit or zero feed-in is needed). (PV > Load, PV + Grid → Load) ② When the power of PV is insufficient Active Charge time period: PV will power the loads firstly, the remaining power will be taken from the grid, the battery will not discharge at this time. (PV + Load, PV + Grid → Load) Active Discharge time period: PV+BAT will power the loads together. If the power is still not enough, the remaining power will be taken from the grid. (PV < Load, PV + Battery + Grid → Load) ③ Without PV power Active Charge time period: The grid supplies the loads and also can charge the battery. (PV=0, Grid → Load + Battery) Active Discharge time period: First, PV supply power to the load, then charge the battery to the set capacity, and then sell the power to the grid. If the local grid company limits the grid-connected power of the inverter, the excess energy continues to charge the battery. (PV > Load, PV + Load → Battery) Active Discharge time period: PV will power the loads firstly, and surplus power will feed-in to the grid. (PV < Load, PV → Load + Grid)											
Feed-in priority	① When the power of PV is sufficient Active Charge time period: PV will power the loads firstly, the remaining power will be taken from the grid. The battery will not discharge. (PV > Load, PV + Grid → Load) Discharge time period: PV+BAT will power the loads together. If the power is still not enough, the remaining power will be taken from the grid. (PV < Load, PV + Battery + Grid → Load) ② When the power of PV is insufficient Active Charge time period: The grid will power the home loads and also charge the battery. (PV=0, Grid → Load + Battery) Active Discharge time period: The battery will power the home loads firstly. If the battery power is not enough, the remaining power will be taken from the grid. The inverter will enter into the standby state. (PV=0, Battery+Grid → Load) Battery min SOC can be set: 10%-100%; Charge battery to min SOC can be set: 10%-100%.											
Backup mode	The back-up mode is suitable for areas with frequent power outages. Same working logic with "Self-use" mode. This mode will maintain the battery capacity at a relatively high level, to ensure that the emergency loads can be used when the grid is off. Customers no need to worry about the battery capacity. Battery min SOC can be set: 30%-100%; Charge battery to min SOC can be set: 30%-100%. In case of power failure, the system will power EPS loads through PV and battery. (Battery must be installed, and EPS loads shall not exceed battery's max. output power) ① When the power of PV is sufficient PV will power the loads firstly, and surplus power will charge to the battery. (PV > Load, PV → Load + Battery) ② When the power of PV is insufficient The remaining power will be taken from the battery. (PV < Load, PV → Load)											
EPS Off-grid	The battery will power the emergency loads until the battery reached the min SOC, then the inverter will enter an idle mode. (PV=0, Battery → Load) EPS(Off-grid) SOC-min condition is adjustable within the range of 10%-25%.											
5*. Export control Export Control Use Value: 10000W	6*. Set work mode Work Mode >Mode Select self use											
7*. External ATS External ATS >Select Enable	5*. Export Control This function allows the inverter able to control energy exported to the grid. There are user value and factory value. The factory value is default which can not be changed by user. The user value set by installer must be less than the factory value.											
	7*. External ATS If an external ATS is to be used, please enable this function, otherwise disable it.											

XI Start Inverter

Start inverter

After the inverter is checked, then conduct the following steps

Applies to most countries

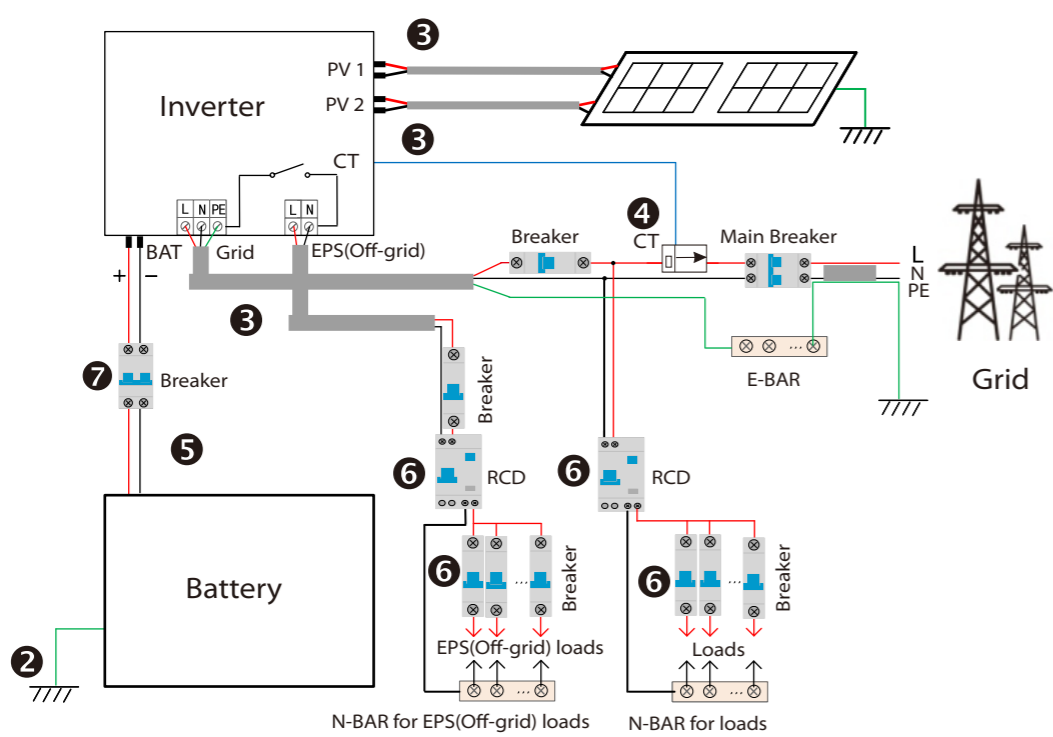

- 1 Make sure that the inverter is fixed on the wall.
- 2 Ensure that all ground wires are grounded.
- 3 Confirm that all DC lines and AC lines are connected.
- 4 Make sure the CT is connected.
- 5 Make sure the battery is well connected.
- 6 Turn on the Load switch and EPS(Off-grid) switch.
- 7 Turn on the battery switch.

Long press Enter for 5 seconds to exit the shutdown mode. Mode is the mode when it is turned off for the first time; factory default: off mode)

XII Firmware Upgrading

In order to upgrade the firmware smoothly, if the DSP and ARM firmware needs to be upgraded, please note that ARM firmware must be upgraded first, then DSP firmware!

-Make sure that this directory is completely consistent with the above table, do not modify the firmware file name, otherwise, the inverter may not work!

-For X1-Hybrid G4, ensure that the PV input voltage is greater than 100V (upgrade on sunny days), please ensure that the battery SOC is greater than 20% or the battery input voltage is greater than 90V. Otherwise, it may cause serious failure during the upgrade process!

-If the ARM firmware upgrade fails or stops, please do not unplug the U disk and power off the inverter and restart it. Then repeat the upgrade steps.

Upgrade preparation

- 1) Please check the inverter version and prepare a U disk (USB 2.0/3.0) and personal computer before upgrading.
- 2) Please contact our service support to obtain the firmware, and store the firmware in the U disk according to the following path.

Update:
 For ARM file:update\ARM\618xxxxx_00_HYB_1P_ARM_Vx.xx_xxxxxxx.usb;
 For DSP file:update\DSP\618xxxxx_00_HYB_1P_DSP_Vx.xx_xxxxxxx.usb;
 Note: Vx.xx is version number, xxxxxxxx is file completion date.

Upgrade steps

Step 1. Please save the "Upgrade" firmware in your U disk first, and press the "Enter" button on the inverter screen for 5 seconds to enter the OFF mode.

Step 2. Find the "Upgrade" port of the inverter, unplug the monitoring module (WiFi Dongle/LAN Dongle/4G Dongle) by hand, and insert the USB flash drive.

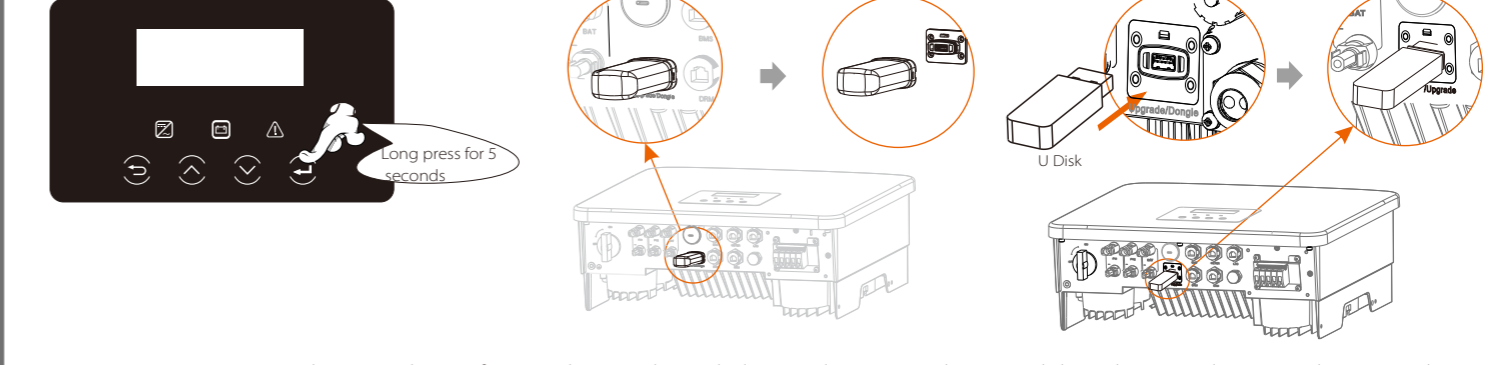

Step 3. LCD operation, enter the upgrade interface "update", as shown below(a); Please press the up and down keys to select ARM, then press the bottom of the page to select "OK", press the enter key to enter the software version interface;

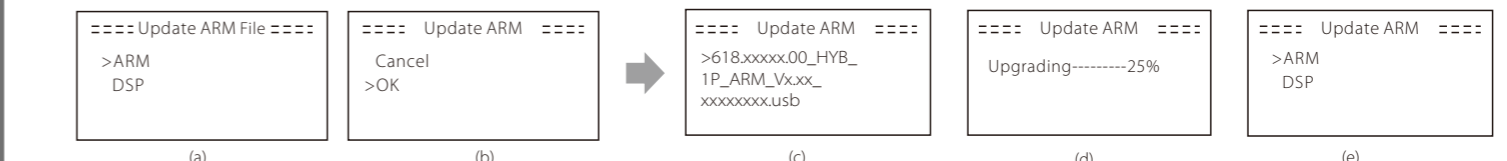

Step 4. Please confirm the new firmware version again and select the firmware to upgrade. The upgrade takes about 20 seconds. (d) When it is completed, the LCD screen returns to the "Update" page.

