



# X3-PRO G2 Series User Manual

8 kW - 30 kW



## SolaX Power Network Technology (Zhejiang) Co., Ltd.

**ADD.:** No. 288, Shizhu Road, Tonglu Economic Development Zone,  
Tonglu City, Zhejiang Province, 310000 P. R. CHINA.

**TEL.:** +86 (0) 571-56260011

**E-mail:** info@solaxpower.com

320101016905

EN

### Copyright Declaration

The copyright of this manual belongs to SolaX Power Network Technology (Zhejiang) Co., Ltd. Any corporation or individual should not plagiarize, partially or fully copy (including software, etc.), and no reproduction or distribution of it in any form or by any means shall be allowed. All rights reserved. SolaX Power Network Technology (Zhejiang) Co., Ltd. reserves the right of final interpretation.

[www.solaxpower.com](http://www.solaxpower.com)

# Contents

- 1 Notes on this Manual ..... 03**
  - 1.1 Scope of Validity.....03
  - 1.2 Target Group .....03
  - 1.3 Symbols Used.....03
  
- 2 Safety ..... 04**
  - 2.1 Appropriate Usage .....04
  - 2.2 Important Safety Instructions .....06
  - 2.3 Explanation of Symbols .....09
  - 2.4 EC Directives ..... 10
  
- 3 Introduction..... 11**
  - 3.1 Basic Features..... 11
  - 3.2 Terminals of the Inverter ..... 11
  - 3.3 Dimension ..... 12
  
- 4 Technical Data..... 13**
  - 4.1 DC Input..... 13
  - 4.2 AC Output ..... 14
  - 4.3 Efficiency, Safety and Protection ..... 16
  - 4.4 General Data ..... 17
  
- 5 Installation ..... 19**
  - 5.1 Check for Transport Damage ..... 19
  - 5.2 Packing List..... 19
  - 5.3 Installation Precaution .....20
  - 5.4 Installation Steps.....21
    - 5.4.1 Installation Space Requirements .....22
    - 5.4.2 Mounting .....23
  
- 6 Electrical Connections..... 26**
  - 6.1 PV Connection.....26
  - 6.2 Grid Connection .....30
  - 6.3 Earth Connection.....35

6.4 Communication Connection.....37

    6.4.1 Monitoring Connection (Optional) .....37

    6.4.2 COM Connection .....38

    6.4.3 RS485/Meter Connection.....40

        6.4.3.1 Meter Connection (Optional).....42

        6.4.3.2 Parallel Connection .....43

        6.4.3.3 EV-Charger Function.....47

        6.4.3.4 Special Notice .....49

    6.4.4 Upgrade.....50

6.5 Run the inverter .....52

**7 Operation Method ..... 53**

    7.1 Control Panel.....53

    7.2 LCD Function & Operation.....54

**8 Troubleshooting ..... 68**

    8.1 Troubleshooting .....68

    8.2 Routine Maintenance.....71

**9 Decommissioning ..... 72**

    9.1 Dismantling the Inverter.....72

    9.2 Packaging.....72

    9.3 Storage and Transportation.....72

    9.4 Waste Disposal.....72

**10 Disclaimer..... 73**

**\* Warranty Registration Form**

# 1 Notes on this Manual

## 1.1 Scope of Validity

This manual is an integral part of X3-PRO G2 Series. It describes the assembly, installation, commissioning, maintenance and failure of the product. Please read it carefully before operating.

X3-PRO-8K-G2(2D)	X3-PRO-10K-G2(2D)	X3-PRO-12K-G2(2D)
X3-PRO-15K-G2(2D)	X3-PRO-17K-G2(2D)	X3-PRO-20K-G2(2D)
X3-PRO-15K-G2(3D)	X3-PRO-17K-G2(3D)	X3-PRO-20K-G2(3D)
X3-PRO-25K-G2(3D)	X3-PRO-30K-G2(3D)	
X3-PRO-10K-G2-LV	X3-PRO-12K-G2-LV	X3-PRO-15K-G2-LV

Note: **“X3”** means three phases. **“PRO”** means product series name. **“8K”** means rated output power is 8 kW. **“G2”** means this product is the second generation machine of the series. **“2D”** means two inputs of MPPT and with DC switch. **“3D”** means three inputs of MPPT and with DC switch. **“LV”** means the inverter works in 127 V a.c. /220 V a.c. low voltage range. Keep this manual at where it is accessible all the time.

## 1.2 Target Group

This manual is for qualified electricians. The tasks described in this manual only can be performed by qualified electricians.

## 1.3 Symbols Used

The following types of safety instructions and general information appear in this document as described below:



**Danger!**  
“Danger” indicates a hazardous situation which, if not avoided, will result in death or serious injury.



**Warning!**  
“Warning” indicates a hazardous situation which, if not avoided, could result in death or serious injury.



**Caution!**  
“Caution” indicates a hazardous situation which, if not avoided, could result in minor or moderate injury.



**Note!**  
“Note” provides tips that are valuable for the optimal operation of your product.

## 2 Safety

### 2.1 Appropriate Usage

The series inverters are PV inverters which can convert DC power from PV generators to AC power and feed it into the public grid.

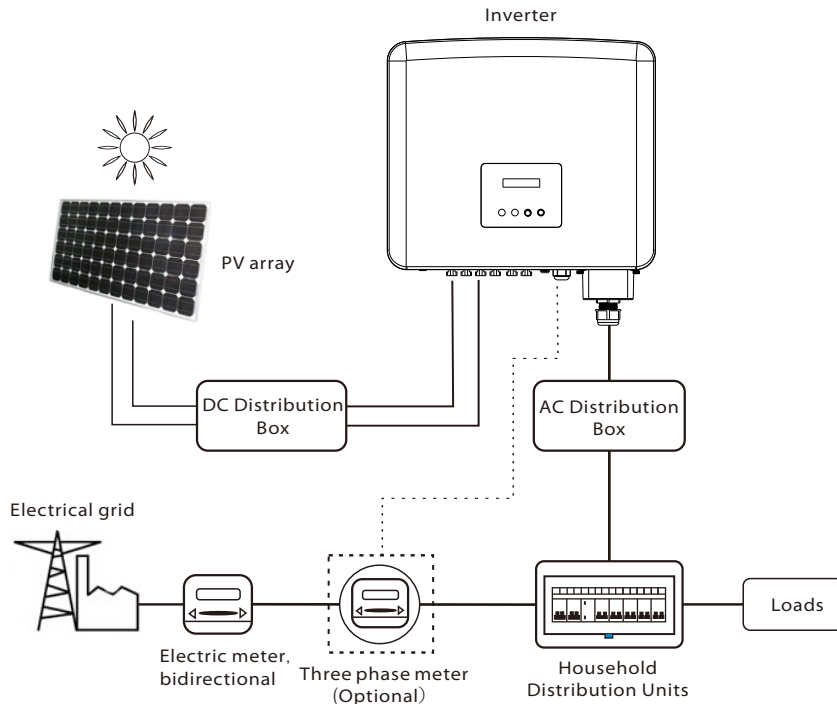

#### ► Surge protection devices (SPDs) for PV installation



**Warning!**

Over-voltage protection with surge arresters should be provided when the PV power system is installed. The grid connected inverter is fitted with SPDs in both PV input side and MAINS side.

Lightning will cause a damage either from a direct strike or from surges due to a nearby strike.

Induced surges are the more likely cause of lightning damage in majority of installations, especially in rural areas where electricity is usually provided by long overhead lines. Surges may be induced on both the PV array conductors or the AC cables leading to the building.

Specialists in lightning protection should be consulted in the actual application. Using appropriate external lightning protection, the effect of a direct lightning strike into a building can be mitigated in a controlled way, and the lightning current can be discharged into the ground.

Installation of SPDs to protect the inverter against mechanical damage and excessive stress include a surge arrester in case of a building with external lightning protection system (LPS) when separation distance is kept.

To protect the DC system, Surge Protection Device (SPD type 2) should be fitted at the inverter end of the DC cabling and at the array located between the inverter and the PV generator, if the voltage protection level (VP) of the surge arresters is greater than 1100V, an additional SPD type 3 required surge protection for electrical devices.

To protect the AC system, surge protection devices (SPD type 2) should be fitted at the main incoming point of AC supply (at the consumer's cutout), located between the inverter and the meter/distribution system; SPD (test impulse D1) for signal line according to EN 61632-1.

All DC cables should be installed to provide as short a run as possible, positive and negative cables of the string or main DC supply should be bundled together. Avoiding the creation of loops in the system. This requirement for short runs and bundling includes any associated earth bundling conductors.

Spark gap devices are not suitable to be used in DC circuits once conducting, they won't stop conducting until the voltage across their terminals is typically more than 30 volts.

#### ► Anti-Islanding Effect

Islanding effect is a special phenomenon that grid-connected PV system still supplies power to the nearby grid when the grid loss happened in the power system. It is dangerous for maintenance personnel and the public. The series inverters provide Active Frequency Drift (AFD) to prevent islanding effect.

## 2.2 Important Safety Instructions



### Danger!

#### Danger to life due to high voltages in the inverter!

- All work must be carried out by qualified electrician.
- The appliance is not to be used by children or persons with reduced physical sensory or mental capabilities, or lack of experience and knowledge, unless they have been given supervision or instruction.
- Children should be supervised to ensure that they do not play with the appliance.



### Caution!

#### Danger of burn injuries due to hot enclosure parts!

- During operation, the upper lid of the enclosure and the enclosure body may become hot.
- If necessary, touch the lower temperature enclosure lid during operation.



### Caution!

#### Possible damage to health as a result of the effects of radiation!

- Do not stay closer than 20 cm to the inverter for a long time.



### Note!

#### Grounding the PV generator.

- Comply with the local requirements for grounding the PV modules and the PV generator. It is recommended to connect the generator frame and other electrically conductive surfaces in a manner which ensures continuous conduction and ground these in order to have optimal protection of system and persons.



### Warning!

- Ensure input DC voltage  $\leq$  Max. DC voltage. Over voltage may cause permanent damage to inverter or other losses, which will not be included in warranty!



### Warning!

- Authorized service personnel must disconnect both AC and DC power from the inverter before attempting any maintenance or cleaning or working on any circuits connected to the inverter.



### Warning!

Do not operate the inverter when the device is running.



### Warning!

Risk of electric shock!

- Prior to the application, please read this section carefully to ensure correct and safe application. Please keep the user manual properly.
- Use only attachments recommended. Otherwise may result in a risk of fire, electric shock, or injury to person.
- Make sure that existing wiring is in good condition and that wire is not undersized.
- Do not disassemble any parts of inverter which are not mentioned in installation guide. It contains no user-serviceable parts. See Warranty for instructions on obtaining service. Attempting to service the inverter yourself may result in a risk of electric shock or fire and will void your warranty. Keep away from flammable, explosive materials to avoid fire disaster.
- The installation place should be away from humid or corrosive substance.
- Authorized service personnel must use insulated tools when installing or working with this equipment.
- PV modules shall have an IEC 61730 class A rating.
- Never touch either the positive or negative pole of PV connecting device. Strictly prohibit touching both of them at the same time.
- The unit contains capacitors that remain charged to a potentially lethal voltage after the MAINS and PV supply have been disconnected.
- Hazardous voltage will present for up to 5 minutes after disconnection from power supply.
- CAUTION - RISK of electric shock from energy stored in capacitor. Never operate on the solar inverter couplers, The MAINS cables, PV cables or the PV generator when power is applied. After switching off the PV and Mains, always wait for 5 minutes to let the intermediate circuit capacitors discharge before you unplug DC and MAINS couplers.
- When accessing the internal circuit of solar inverter, it is very important to wait 5 minutes before operating the power circuit or demounting the electrolyte capacitors inside the device. Do not open the device before hand since the capacitors require time to sufficiently discharge!
- Measure the voltage between terminals UDC+ and UDC- with a multi-meter (impedance at least 1 Mohm) to ensure that the device is discharged before beginning work (35 VDC) inside the device.

**PE Connection and Leakage Current**

- All inverters incorporate a certified internal Residual Current Device(RCD) in order to protect against possible electrocution and fire hazard in case of a malfunction in the PV array, cables or inverter. There are 2 trip thresholds for the RCD as required for certification (IEC 62109-2:2011). The default value for electrocution protection is 30 mA, and for slow rising current is 300 mA.
- If an external RCD is required by local regulations, it is recommended to choose a Type-A RCD with the rating residual current of 300 mA.

	<p><b>Warning!</b> High leakage current! Earth connection essential before connecting supply.</p>
---	---

- Incorrect grounding can cause physical injury, death or equipment malfunction and increase electromagnetic.
- Make sure that grounding conductor is adequately sized as required by safety regulations.
- Do not connect the ground terminals of the unit in series in case of a multiple installation. This product can cause current with a d.c. component. Where a residual current operated protective (RCD) or monitoring (RCM) device is used for protection in case of direct or indirect contact, only an RCD or RCM is allowed on the supply side of this product.

**For United Kingdom**

- The installation that connects the equipment to the supply terminals shall comply with the requirements of BS 7671.
- Electrical installation of PV system shall comply with requirements of BS 7671 and IEC 60364-7-712.
- No protection settings can be altered.
- User shall ensure that equipment is so installed, designed and operated to maintain at all times compliance with the requirements of ESQCR22(1)(a).



**For Australia and New Zealand**

- Electrical installation and maintenance shall be conducted by licensed electrician and shall comply with Australia National Wiring Rules.













**2.3 Explanation of Symbols**

This section gives an explanation of all the symbols shown on the inverter and on the type label.

• **Symbols on the Inverter**

Symbol	Explanation
	Operating Display.
	An error has occurred, please inform your installer immediately.

• **Symbols on the Type Label**

Symbol	Explanation
	CE mark. The inverter complies with the requirements of the applicable CE guidelines.
	Compliant with UKCA standards.
	Compliant with UKNI standards.
	RCM remark.
	TUV certification.
	Beware of hot surface. The inverter can become hot during operation. Avoid contact during operation.
	Danger of high voltages. Danger to life due to high voltages in the inverter!
	Danger. Risk of electric shock!
	Observe enclosed documentation.
	The inverter can not be disposed together with the household waste. Disposal information can be found in the enclosed documentation.
	Do not operate this inverter until it is isolated from mains and on-site PV generation suppliers.
	Danger to life due to high voltage. There is residual voltage in the inverter which needs 5 min to discharge. • Wait 5 min before you open the upper lid or the DC lid.
	RoHS certificate The inverter complies with the requirements of Restriction of Hazardous Substances.

## 2.4 EC Directives

This section describes the requirements of the European low voltage regulations, including safety instructions and system licensing conditions, the user must comply with these regulations when installing, operating, and maintaining the inverter, otherwise personal injury or death may occur, and the inverter will be damaged. Please read the manual carefully when operating the inverter. If you do not understand "Danger", "Warning", "Caution" and the descriptions in the manual, please contact the manufacturer or service agent before installing and operating the inverter.

Make sure that the whole system complies with the requirements of EC(2014/35/EU, 2014/30/EU, etc.) before starting the module (i.e. to start the operation).

Standard of 2014/35/EU (LVD)  
EN IEC 62109-1; EN IEC 62109-2  
EN 62477-1

Standard of 2014/30/EU (EMC)  
EN IEC 61000-6-1; EN IEC 61000-6-2;  
EN IEC 61000-6-3; EN IEC 61000-6-4;  
EN IEC 61000-3-2; EN 61000-3-3;  
EN IEC 61000-3-11; EN 61000-3-12  
EN 55011

The assembly shall be installed in accordance with the statutory wiring rules. Install and configure the system in accordance with safety rules, including the use of specified wiring methods. The installation of the system can only be done by professional assemblers who are familiar with safety requirements and EMC. The assembler shall ensure that the system complies with the relevant national laws.

The individual subassembly of the system shall be interconnected by means of the wiring methods outlined in national/international such as the national electric code (NFPA) No. 70 or VDE regulation 4105.

## 3 Introduction

### 3.1 Basic Features

Thanks for your purchasing with the series inverter. The series inverter is one of the finest inverters on the market today, incorporating state-of-the-art technology, high reliability, and convenient control features.

- Advanced DSP control technology.
- Utilize the latest high-efficiency power component.
- Optimal MPPT technology.
  - 2/3 MPP Tracking.
  - Wide MPPT input range.
- Advanced anti-islanding solutions.
- IP66 protection level.
- Max. efficiency up to 98.5%. EU efficiency up to 98.0%.
- THD<3%.
- Safety & Reliability: transformerless design with software and hardware protection.
- Export control.
- Power factor regulation.
- Friendly HMI.
  - LED status indications.
  - LCD display technical data, human-machine interaction through press key.
  - PC remote control.
  - Upgrade through USB interface.
  - WiFi/LAN/4G dongle monitoring.

### 3.2 Terminals of the Inverter

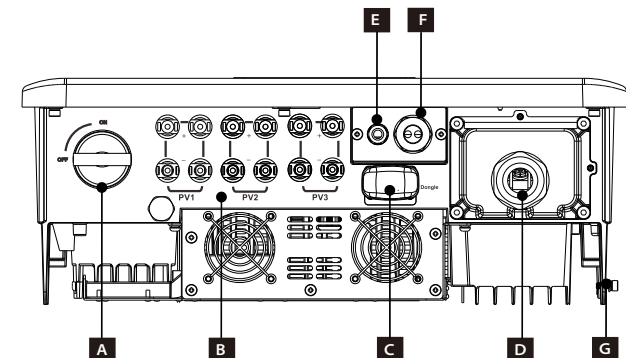

Object	Description
A	DC switch
B	PV connector
C	Dongle port for WiFi /LAN /4G (optional)
D	AC connector
E	COM
F	RS485
G	Ground connection port

**Warning!**

Only authorized personnel is allowed to set the connection.

## 3.3 Dimension

## ➤ Dimension

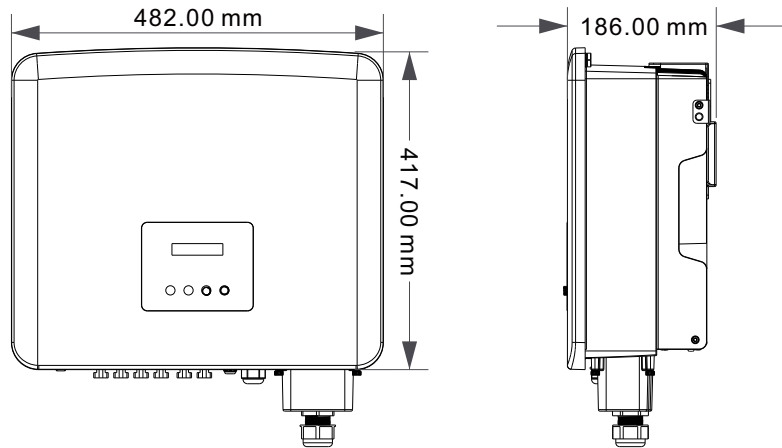

## 4 Technical Data

## 4.1 DC Input

Model	X3-PRO-8K-G2(2D)	X3-PRO-10K-G2(2D)	X3-PRO-12K-G2(2D)	X3-PRO-15K-G2(2D)	X3-PRO-17K-G2(2D)	X3-PRO-20K-G2(2D)
Max. recommended DC power [W]	12000	15000	18000	22500	25500	30000
Max. DC voltage [V]	1100	1100	1100	1100	1100	1100
Nominal DC operating voltage [V]	650	650	650	650	650	650
MPPT voltage range [V]	160-980	160-980	160-980	160-980	160-980	160-980
MPPT voltage range@full load [V]	350-850	350-850	350-850	400-850	400-850	400-850
Max. input current [A]	32/32	32/32	32/32	32/32	32/32	32/32
Max. short circuit current [A]	40/40	40/40	40/40	40/40	40/40	40/40
Start input voltage [V]	200	200	200	200	200	200
No. of MPPT trackers	2	2	2	2	2	2
Strings per MPPT tracker	A:2/B:2	A:2/B:2	A:2/B:2	A:2/B:2	A:2/B:2	A:2/B:2
Max. MPPT power limit per MPPT [W]*	8000	10000	12000	12000	12000	12000
DC disconnection switch	Yes					
Max. inverter backfeed current to the array [mA]	0					

Model	X3-PRO-15K-G2(3D)	X3-PRO-17K-G2(3D)	X3-PRO-20K-G2(3D)	X3-PRO-25K-G2(3D)	X3-PRO-30K-G2(3D)
Max. recommended DC power [W]	22500	25500	30000	37500	45000
Max. DC voltage [V]	1100	1100	1100	1100	1100
Nominal DC operating voltage [V]	650	650	650	650	650
MPPT voltage range [V]	160-980	160-980	160-980	160-980	160-980
MPPT voltage range@full load [V]	400-850	400-850	400-850	500-850	500-850
Max. input current [A]	32/32/32	32/32/32	32/32/32	32/32/32	32/32/32
Max. short circuit current [A]	40/40/40	40/40/40	40/40/40	40/40/40	40/40/40
Start input voltage [V]	200	200	200	200	200
No. of MPPT trackers	3	3	3	3	3
Strings per MPPT tracker	A:2/B:2/C:2	A:2/B:2/C:2	A:2/B:2/C:2	A:2/B:2/C:2	A:2/B:2/C:2
Max. MPPT power limit per MPPT [W]*	12000	12000	12000	15000	15000
DC disconnection switch	Yes				
Max. inverter backfeed current to the array [mA]	0				



Model	X3-PRO-10K-G2-LV	X3-PRO-12K-G2-LV	X3-PRO-15K-G2-LV
Max. recommended DC power [W]	15000	18000	22500
Max. DC voltage [V]	800	800	800
Nominal DC operating voltage [V]	360	360	360
MPPT voltage range [V]	160-650	160-650	160-650
MPPT voltage range@full load [V]	300-550	300-550	300-550
Max. input current [A]	32/32	32/32	32/32
Max. short circuit current [A]	40/40	40/40	40/40
Start input voltage [V]	200	200	200
No. of MPP trackers	2	2	2
Strings per MPP tracker	A:2/B:2	A:2/B:2	A:2/B:2
Max. MPPT power limit per MPPT [W]*	10000	12000	15000
DC disconnection switch	Yes		
Max. inverter backfeed current to the array [mA]	0		

\* "Max. MPPT power limit per MPPT" means the maximum PV production when using one of the MPPTs only.

## 4.2 AC Output

Model	X3-PRO-8K-G2(2D)	X3-PRO-10K-G2(2D)	X3-PRO-12K-G2(2D)	X3-PRO-15K-G2(2D)	X3-PRO-17K-G2(2D)	X3-PRO-20K-G2(2D)
Nominal AC power [VA]	8000	10000	12000	15000	17000	20000
Max. apparent AC power [VA]	8800	11000	13200	16500	18700	22000
Rated grid voltage [V]	3~/N/PE, 220/380 V, 230/400 V; 3~/PE, 380 V, 400 V					
Rated AC frequency [Hz]	50/60					
Nominal AC current [A]	12.2/11.6	15.2/14.5	18.2/17.4	22.8/21.8	25.8/24.7	30.3/29.0
Max. AC current [A]	13.2	16.0	19.3	24.2	27.5	33.6
THDi	<3%					
Displacement power factor	0.8 leading-0.8 lagging					
Feed-in phase	Three-phase					

Model	X3-PRO-15K-G2(3D)	X3-PRO-17K-G2(3D)	X3-PRO-20K-G2(3D)	X3-PRO-25K-G2(3D)	X3-PRO-30K-G2(3D)
Nominal AC power [VA]	15000	17000	20000	25000	30000
Max. apparent AC power [VA]	16500	18700	22000	27500	30000
Rated grid voltage [V]	3~/N/PE, 220/380 V, 230/400 V; 3~/PE, 380 V, 400 V				
Rated AC frequency [Hz]	50/60				
Nominal AC current [A]	22.8/21.8	25.8/24.7	30.3/29.0	37.9/36.3	45.5/43.5
Max. AC current [A]	24.2	27.5	33.6	41.8	45.5
THDi	<3%				
Displacement power factor	0.8 leading-0.8 lagging				
Feed-in phase	Three-phase				

Model	X3-PRO-10K-G2-LV	X3-PRO-12K-G2-LV	X3-PRO-15K-G2-LV
Nominal AC power [VA]	10000	12000	15000
Max. apparent AC power [VA]	11000	13200	16500
Rated grid voltage [V]	3~/N/PE, 127/220 V; 3~/PE, 220 V		
Rated AC frequency [Hz]	50/60		
Nominal AC current [A]	26.3	31.5	39.4
Max. AC current [A]	28.9	34.7	43.4
THDi	<3%		
Displacement power factor	0.8 leading-0.8 lagging		
Feed-in phase	Three-phase		

### 4.3 Efficiency, Safety and Protection

Model	X3-PRO-8K-G2(2D)	X3-PRO-10K-G2(2D)	X3-PRO-12K-G2(2D)	X3-PRO-15K-G2(2D)	X3-PRO-17K-G2(2D)	X3-PRO-20K-G2(2D)
MPPT efficiency	99.90%	99.90%	99.90%	99.90%	99.90%	99.90%
Euro efficiency	97.70%	97.70%	97.70%	97.80%	97.80%	97.80%
Max. efficiency	98.20%	98.20%	98.20%	98.30%	98.30%	98.30%
<b>Safety &amp; Protection</b>						
Over/under voltage protection	Yes					
DC isolation protection	Yes					
Grid monitoring	Yes					
DC injection monitoring	Yes					
Back feed current monitoring	Yes					
Residual current detection	Yes					
Anti-islanding protection	Yes					
Over temperature protection	Yes					
ARC detection	Optional					
SPD protection	Type II					
Arc-fault circuit interrupter(AFCI)	Optional					
AC auxiliary power supply(APS)	Optional					

Model	X3-PRO-10K-G2-LV	X3-PRO-12K-G2-LV	X3-PRO-15K-G2-LV
MPPT efficiency	99.90%	99.90%	99.90%
Euro efficiency	97.20%	97.20%	97.20%
Max. efficiency	97.70%	97.70%	97.70%
<b>Safety &amp; Protection</b>			
Over/under voltage protection	Yes		
DC isolation protection	Yes		
Grid monitoring	Yes		
DC injection monitoring	Yes		
Back feed current monitoring	Yes		
Residual current detection	Yes		
Anti-islanding protection	Yes		
Over temperature protection	Yes		
ARC detection	Optional		
SPD protection	Type II		
Arc-fault circuit interrupter(AFCI)	Optional		
AC auxiliary power supply(APS)	Optional		

Model	X3-PRO-15K-G2(3D)	X3-PRO-17K-G2(3D)	X3-PRO-20K-G2(3D)	X3-PRO-25K-G2(3D)	X3-PRO-30K-G2(3D)
MPPT efficiency	99.90%	99.90%	99.90%	99.90%	99.90%
Euro efficiency	97.80%	97.80%	97.80%	98.00%	98.00%
Max. efficiency	98.30%	98.30%	98.30%	98.50%	98.50%
<b>Safety &amp; Protection</b>					
Over/under voltage protection	Yes				
DC isolation protection	Yes				
Grid monitoring	Yes				
DC injection monitoring	Yes				
Back feed current monitoring	Yes				
Residual current detection	Yes				
Anti-islanding protection	Yes				
Over temperature protection	Yes				
ARC detection	Optional				
SPD protection	Type II				
Arc-fault circuit interrupter(AFCI)	Optional				
AC auxiliary power supply(APS)	Optional				

### 4.4 General Data

Model	X3-PRO-8K-G2(2D)	X3-PRO-10K-G2(2D)	X3-PRO-12K-G2(2D)	X3-PRO-15K-G2(2D)	X3-PRO-17K-G2(2D)	X3-PRO-20K-G2(2D)
Dimension (W/H/D)[mm]	482x417x186					
Dimension of packing (W/H/D)[mm]	590x530x315					
Net weight [kg]	24.5	24.5	24.5	26	26	26
Gross weight [kg]	28.5	28.5	28.5	30	30	30
Installation	Wall-mounted					
Operating temperature range [°C]	-30~+60 (Derating at 45)					
Storage temperature [°C]	-30~+60					
Storage/Operation relative humidity	0%~100%, condensation					
Altitude [m]	4000(>3000 derating)					
Ingress protection	IP66					
Isolation type	Transformerless					
Protective class	I					
Night-time consumption	<3 W					
Over voltage category	III(MAINS), II(PV)					
Pollution degree	II					
Cooling concept	Natural cooling			Smart fan cooling		
Noise level	<35 dB			<55 dB		
Inverter Topology	Non-isolated					
Communication interface	Meter, USB, Modbus RTU, WiFi/LAN/4G (Optional), DRM					

Model	X3-PRO-15K-G2(3D)	X3-PRO-17K-G2(3D)	X3-PRO-20K-G2(3D)	X3-PRO-25K-G2(3D)	X3-PRO-30K-G2(3D)
Dimension (W/H/D)[mm]	482x417x186				
Dimension of packing (W/H/D)[mm]	590x530x315				
Net weight [kg]	27.5	27.5	27.5	28	28
Gross weight [kg]	31.5	31.5	31.5	32	32
Installation	Wall-mounted				
Operating temperature range [°C]	-30~+60 (Derating at 45)				
Storage temperature [°C]	-30~+60				
Storage/Operation relative humidity	0%~100%, condensation				
Altitude [m]	4000(>3000 derating)				
Ingress protection	IP66				
Isolation type	Transformerless				
Protective class	I				
Night-time consumption	<3 W				
Over voltage category	III(MAINS), II(PV)				
Pollution degree	II				
Cooling concept	Smart fan cooling				
Noise level	<55 dB			<58 dB	
Inverter Topology	Non-isolated				
Communication interface	Meter, USB, Modbus RTU, WiFi/LAN/4G (Optional), DRM				

Model	X3-PRO-10K-G2-LV	X3-PRO-12K-G2-LV	X3-PRO-15K-G2-LV
Dimension (W/H/D)[mm]	482x417x186		
Dimension of packing (W/H/D)[mm]	590x530x315		
Net weight [kg]	27.5	28	28
Gross weight [kg]	31.5	32	32
Installation	Wall-mounted		
Operating temperature range [°C]	-30~+60 (Derating at 45)		
Storage temperature [°C]	-30~+60		
Storage/Operation relative humidity	0%~100%, condensation		
Altitude [m]	4000(>3000 derating)		
Ingress protection	IP66		
Isolation type	Transformerless		
Protective class	I		
Night-time consumption	<3 W		
Over voltage category	III(MAINS), II(PV)		
Pollution degree	II		
Cooling concept	Smart fan cooling		
Noise level	<45 dB	<55 dB	<58 dB
Inverter Topology	Non-isolated		
Communication interface	Meter, USB, Modbus RTU, WiFi/LAN/4G (Optional), DRM		

## 5 Installation

### 5.1 Check for Transport Damage

Make sure the inverter is intact during transportation. If there are some visible damages, such as cracks, please contact your dealer immediately.

### 5.2 Packing List

Open the package and fetch out the product, check the accessories at first. The packing list is shown as below.

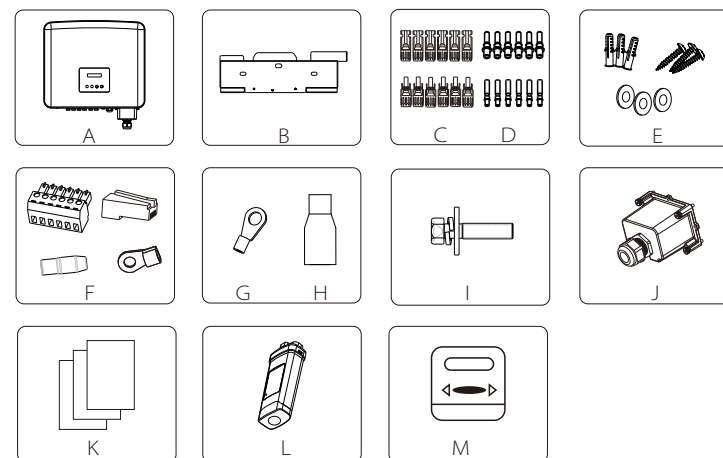

Object	Quantity	Description
A	1	Inverter
B	1	Bracket
C	8/12	PV terminal (positive*4 , negative*4 for two inputs, positive*6 , negative*6 for three inputs)
D	8/12	PV pin contact (positive*4 , negative*4 for two inputs, positive*6 , negative*6 for three inputs)
E	9	(Expansion bolt, Gasket, Self-tapping screw)*3
F	4	Terminal block*1, RJ45 connector*1, Terminal sleeve*1, R-type terminal*1
G	5	OT terminal*5
H	5	Terminal cover*5
I	1	M5 inner hexagonal screw
J	1	AC waterproof cover
K	/	Documents
L	1	WiFi/LAN/4G dongle (Optional)
M	1	Meter (Optional)

\*For the optional accessories, please be subject to the actual delivery.

### 5.3 Installation Precaution

The series inverter is designed for outdoor installation (IP66). Make sure the installation site meets the following conditions:

- Not in direct sunlight.
  - Not in areas where highly flammable materials are stored.
  - Not in potential explosive areas.
  - Not near the television antenna or antenna cable.
  - Not higher than altitude of about 4000 m above sea level.
  - Not in environment of precipitation or humidity.
  - Be sure the ventilation is good enough.
  - The ambient temperature in the range of -30°C to +60°C.
  - The slope of the wall should be within  $\pm 5^\circ$ .
- The wall hanging the inverter should meet conditions below:
1. solid brick/concrete, or strength equivalent mounting surface;
  2. Inverter must be supported or strengthened if the wall's strength isn't enough (such as wooden wall, the wall covered by thick layer of decoration)

Please avoid direct sunlight, rain exposure, snow laying up during installing and operating.

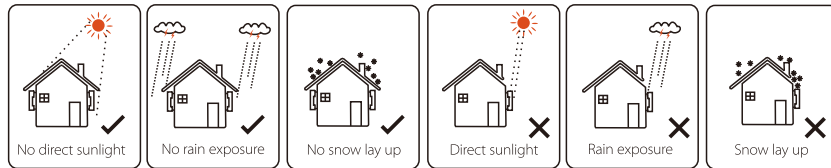

**Note!** Please do not install the inverters in parallel connection before confirming with local installer or us. For more details, please contact us.

### 5.4 Installation Steps

#### ► Preparation

Below tools are needed before installation.

Tool equipment				
Type	Name	Image	Name	Image
Machine Installation Tools	Hammer drill	Bit $\Phi 10$ 	Multimeter	DC Voltage Range $\geq 1100$ VDC 
	Torque screwdriver	Crosshead M5 	Outer hexagonal wrench	
	OT terminal press clamp	$0.5 \text{ mm}^2 \sim 10 \text{ mm}^2$ 	Diagonal pliers	
	Utility knife		Multifunction terminal crimping tool (RJ45)	
	Wire stripper		Marker	
	Rubber hammer		Tape measure	
	Crimping Tool		Inner hexagonal wrench	
	Screwdrivers Wrench			
Individual Protection Tools	Safety gloves		Protective glasses	

### 5.4.1 Installation Space Requirements

Reserve enough space when installing inverter (at least 300 mm) for heat dissipation.

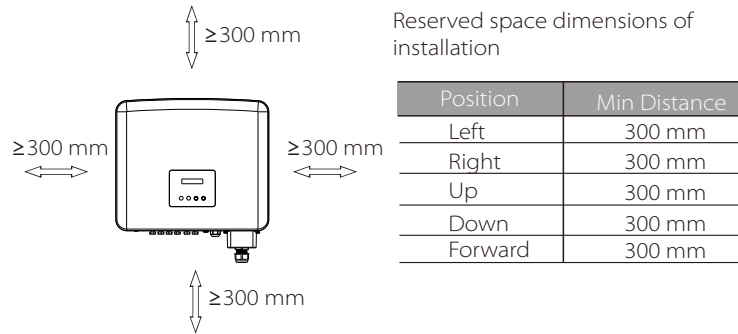

The distance of installation space for multiple inverters is as follows:

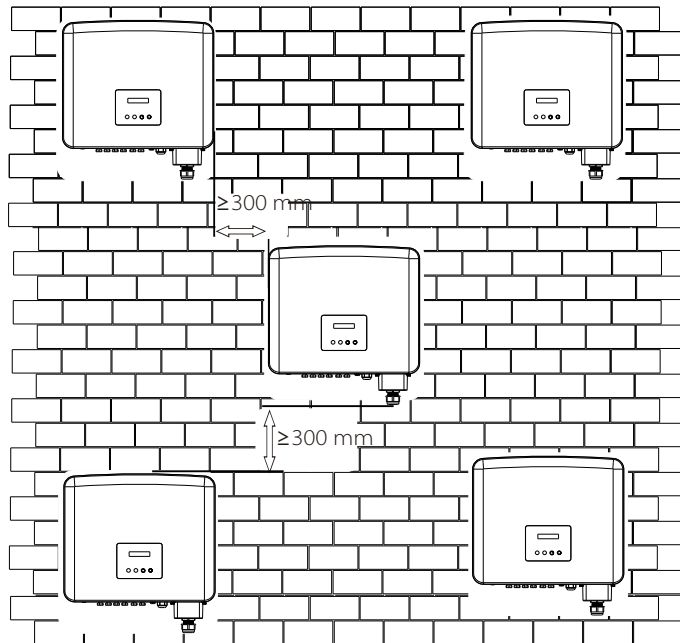

### 5.4.2 Mounting

➤ Step 1: Fix the bracket to the wall.

First find the expansion screws and the bracket in the accessory bag, as shown below:

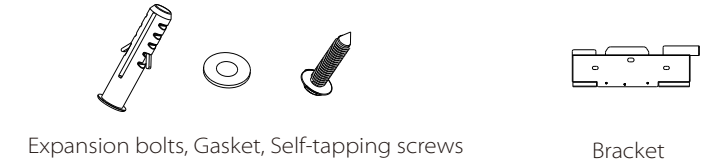

- a) Mark the holes on the wall with a marker.
- b) Drill holes at the marked points to a depth of at least 60 mm.

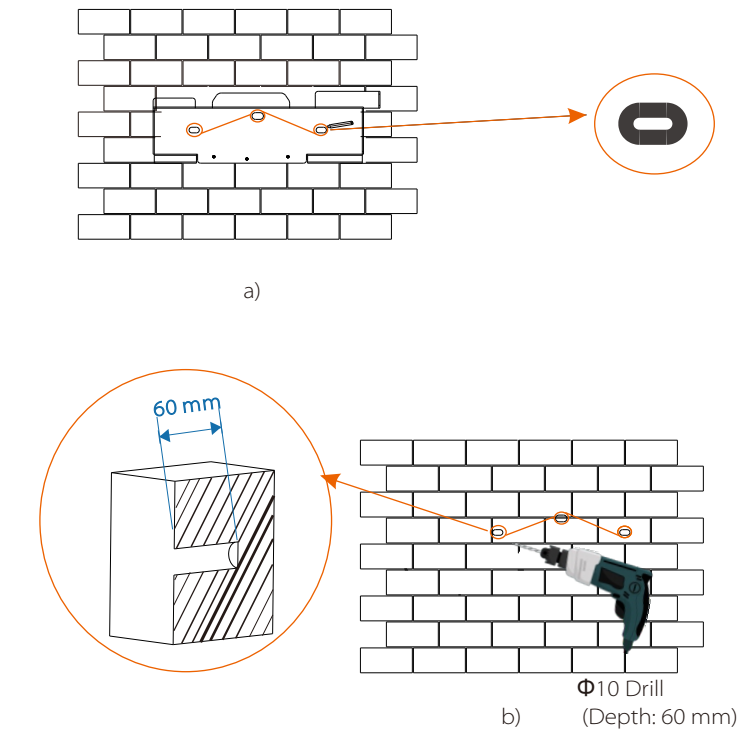

- c) Insert expansion bolts into the holes, use rubber hammer to knock the expansion bolts into the wall.
- d) Insert the self-tapping screws into the gaskets and use the outer hexagon wrench to tighten them.

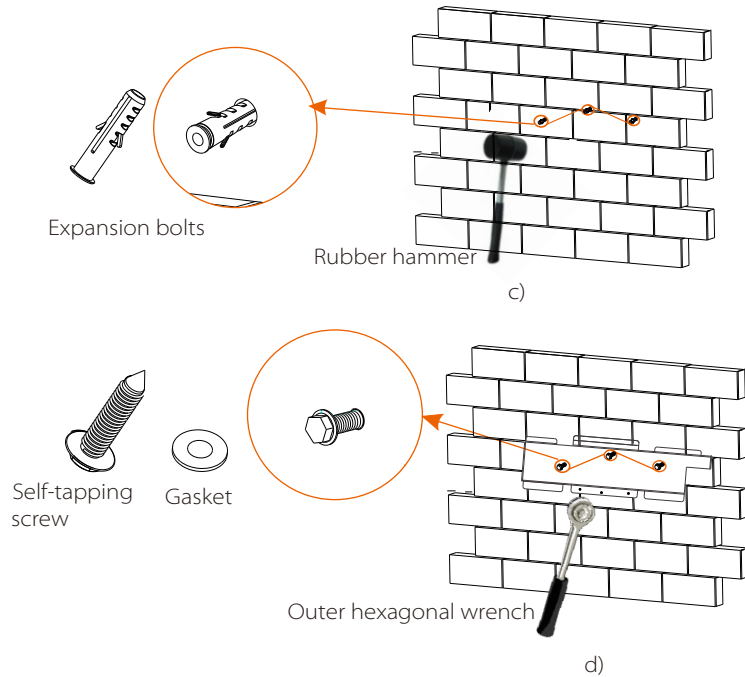

➤ Step 2: Hang the inverter on the bracket.

e) Hang the buckle of the inverter to the corresponding position of the bracket;

➤ Step 3: Tighten the inverter and bracket.

f) Use the inner hexagonal wrench to tighten the inner hexagonal screw on the right side of the inverter.

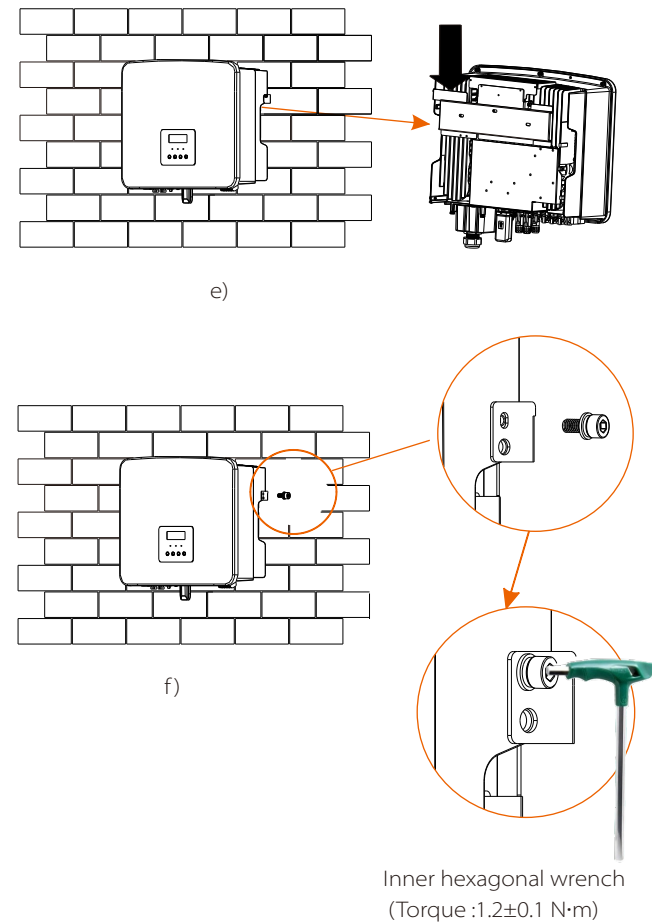

## 6 Electrical Connections

### 6.1 PV Connection

The series inverter have three couples of PV connectors which can be connected in series into at most 3-inputs of PV modules. Please select photovoltaic modules with good performance and quality assurance. The open circuit voltage of the module array should be less than the maximum PV input voltage specified by the inverter, and the operating voltage should be within the MPPT voltage range.

Table: Max. DC Voltage Limitation

Model	X3-PRO-8K-G2(2D)	X3-PRO-10K-G2(2D)	X3-PRO-12K-G2(2D)	X3-PRO-15K-G2(2D)	X3-PRO-17K-G2(2D)	X3-PRO-20K-G2(2D)
Max. DC Voltage	1100V					

Model	X3-PRO-15K-G2(3D)	X3-PRO-17K-G2(3D)	X3-PRO-20K-G2(3D)	X3-PRO-25K-G2(3D)	X3-PRO-30K-G2(3D)
Max. DC Voltage	1100V				

Model	X3-PRO-10K-G2-LV	X3-PRO-12K-G2-LV	X3-PRO-15K-G2-LV
Max. DC Voltage	800V		

**Danger!**  

 Danger to life due to high voltage on DC conductors. when exposed to sunlight, the PV array generates dangerous DC voltage which is present in the DC conductors. Touching the DC conductors can lead to lethal electric shocks. Do not cover the PV modules. Do not touch the DC conductors.

**Warning!**  

 The voltage of PV modules is very high and dangerous , please comply with the electric safety rules when connecting.

**Warning!**  

 Do not ground the positive or negative pole of the photovoltaic module!

**Note!**  

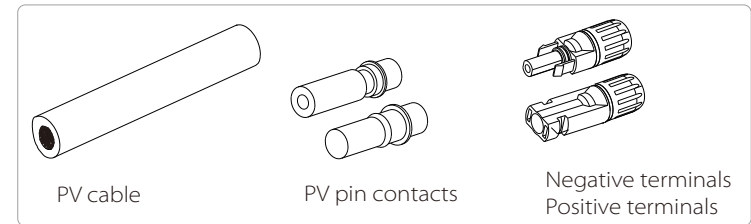
 Please follow the requirements of PV modules as below: Same type; Same quantity; Identical alignment; Identical tilt. In order to save cable and reduce the DC loss, we suggest installing the inverter near PV modules.

### • Connection Steps

Step 1. Turn off the DC switch, connect the PV module, prepare a 4 mm<sup>2</sup> PV cable, and find the PV (+) terminals and PV (-) terminals in the package.

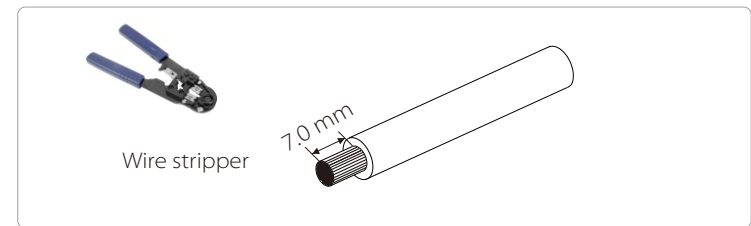

Step 2. Use a wire stripper to strip 7 mm insulation layer from the wire end.



Step 3. Tighten the cable with the insulation layer stripped and insert it into the pin contact (see Figure 1), make sure all wires are inserted into the pin contact (see Figure 2).

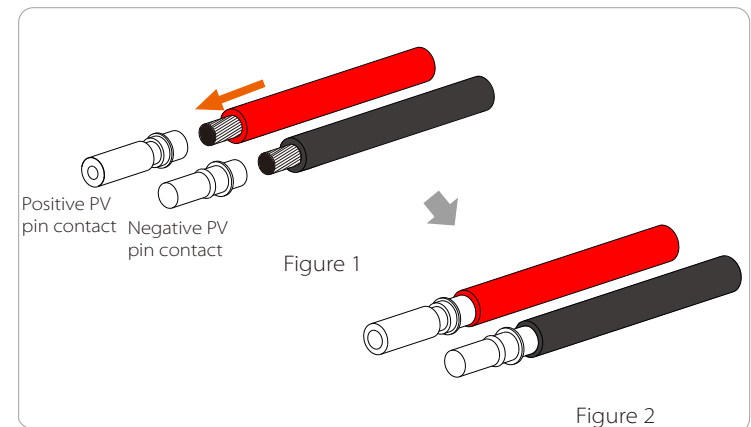

Step 4. Tighten the PV pin contact and the wiring harness to make the connection tight without looseness.

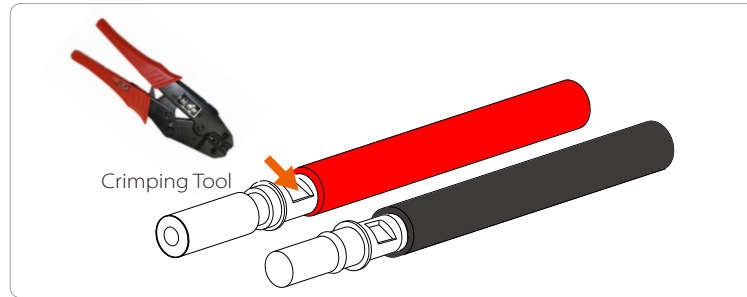

Step 5. Divide the PV terminal into 2 parts - the plug and the fastening head. Insert the cable through the fastening head and the corresponding plug. Note that the red and black lines correspond to different plugs. Finally, force the cable pair into the plug, there will be a "click" sound, which indicates that the connection is completed.

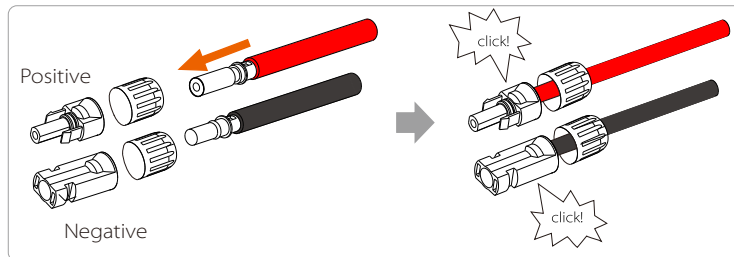

Step 6. Tighten the fastening head and insert into the corresponding positive and negative (PV+/PV-) ports of the inverter.

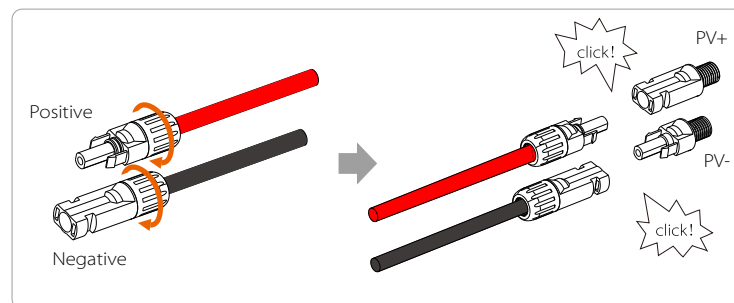

The following is the location of the inverter's positive and negative (PV+/PV-) ports.

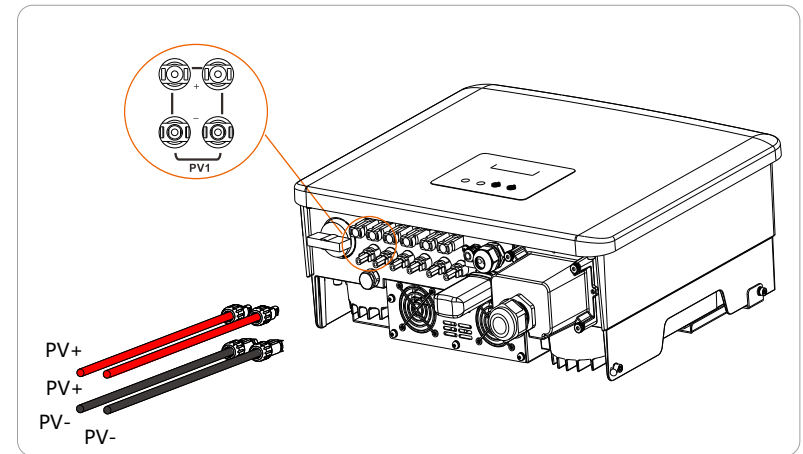

Schematic diagram of the inverter PV connected.

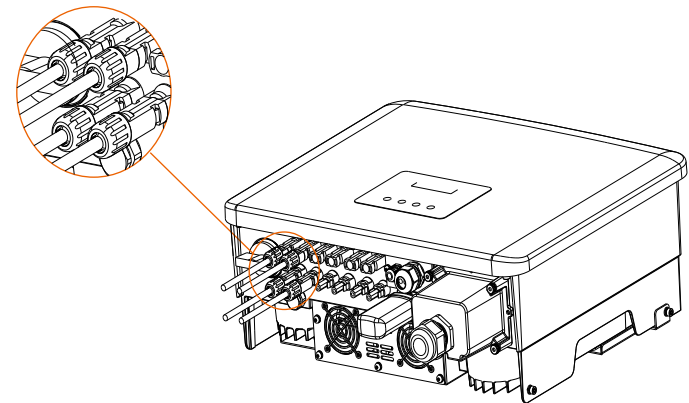



### 6.2 Grid Connection

The series inverter are designed for three phase grid. For the rated grid voltage and frequency, please refer to the section "Technical Data". Other technical requests should comply with the requirement of the local public grid.

Table: Cable and Micro-breaker recommended

Model	X3-PRO-8K-G2(2D)	X3-PRO-10K-G2(2D)	X3-PRO-12K-G2(2D)	X3-PRO-15K-G2(2D)	X3-PRO-17K-G2(2D)	X3-PRO-20K-G2(2D)
L1, L2, L3 Cable	4-5 mm <sup>2</sup>	5-6 mm <sup>2</sup>	5-6 mm <sup>2</sup>	5-6 mm <sup>2</sup>	6-8 mm <sup>2</sup>	6-8 mm <sup>2</sup>
PE, N Cable	2.5-5 mm <sup>2</sup>	3-6 mm <sup>2</sup>	3-6 mm <sup>2</sup>	3-6 mm <sup>2</sup>	3-6 mm <sup>2</sup>	3-6 mm <sup>2</sup>
Micro-breaker	16 A	20 A	25 A	32 A	40 A	40 A

Model	X3-PRO-15K-G2(3D)	X3-PRO-17K-G2(3D)	X3-PRO-20K-G2(3D)	X3-PRO-25K-G2(3D)	X3-PRO-30K-G2(3D)
L1, L2, L3 Cable	5-6 mm <sup>2</sup>	6-8 mm <sup>2</sup>	6-8 mm <sup>2</sup>	8-10 mm <sup>2</sup>	10 mm <sup>2</sup>
PE, N Cable	3-6 mm <sup>2</sup>	3-6 mm <sup>2</sup>	3-6 mm <sup>2</sup>	3-6 mm <sup>2</sup>	3-6 mm <sup>2</sup>
Micro-breaker	32 A	40 A	40 A	50 A	63 A

Model	X3-PRO-10K-G2-LV	X3-PRO-12K-G2-LV	X3-PRO-15K-G2-LV
L1, L2, L3 Cable	6-8 mm <sup>2</sup>	8-10 mm <sup>2</sup>	10 mm <sup>2</sup>
PE, N Cable	3-6 mm <sup>2</sup>	3-6 mm <sup>2</sup>	3-6 mm <sup>2</sup>
Micro-breaker	40 A	50 A	63 A

\*The parameters have some differences because of different environment and material. Please choose appropriate cable and micro-breaker according to the local conditions.

Micro-breaker should be installed between inverter and grid, any loads should not be connected with inverter directly.

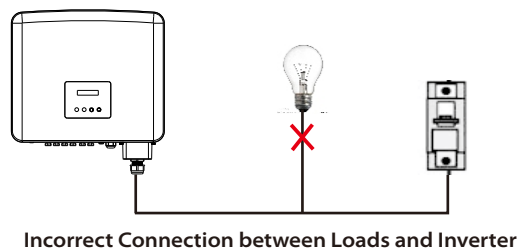

#### • Connection Steps

Note: Check the grid voltage and compare with the permissive voltage range (refer to technical data).

- a) Disconnect the circuit-bricker from all the phases and secure against re-connection.
- b) Select appropriate cable and prepare to strip the wires:
  - Strip 82 mm of insulation from the cable end.
  - Use the stripping pliers to strip 12 mm of insulation from wire ends as below.

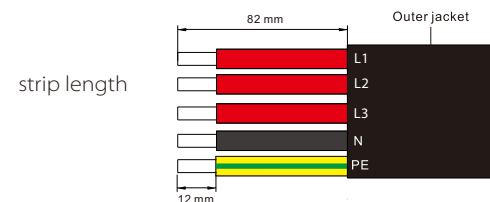

- c) Fetch the AC waterproof cover from the carton.

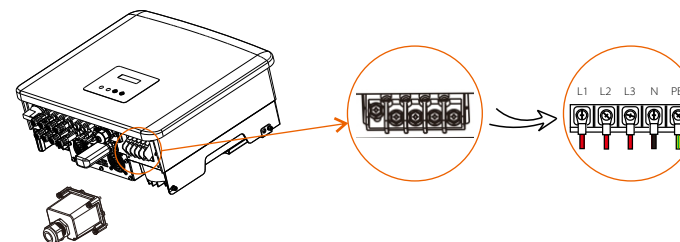

- d) Unscrew the fastening nut of the AC waterproof cover and remove the sealing rings. Select appropriate number of the sealing rings according to the outer diameter of the cable. Let the cable pass through the fastening nut, the sealing ring(s) and the waterproof cover in sequence.

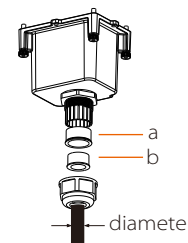

Diameter(mm)	Sealing ring(s)
12~18	a+b
18~25	a

e) Strip 82 mm of insulation from the cable ends by using the stripping pliers.

f) Crimp the wire ends by using the wire crimper.

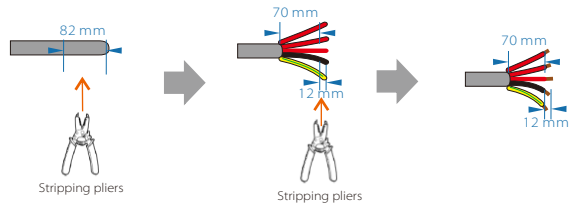

g) Pull one terminal cover each over conductors L1, L2, L3, N and the grounding conductor. The terminal cover must be below the stripped conductor section.

h) Use the OT terminal crimping tool to press OT terminals.

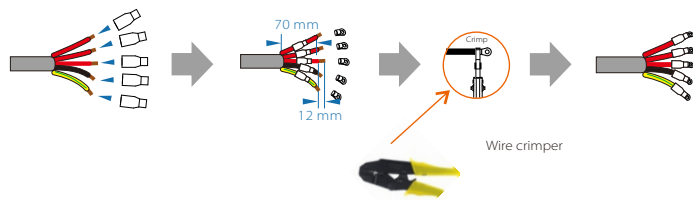

i) Tighten the screws of the wire ends with a screwdriver.

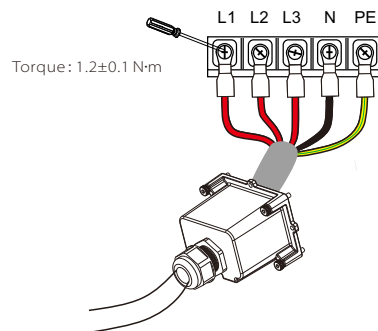

j) Align the waterproof cover and tighten the four screws with an inner hexagonal wrench.

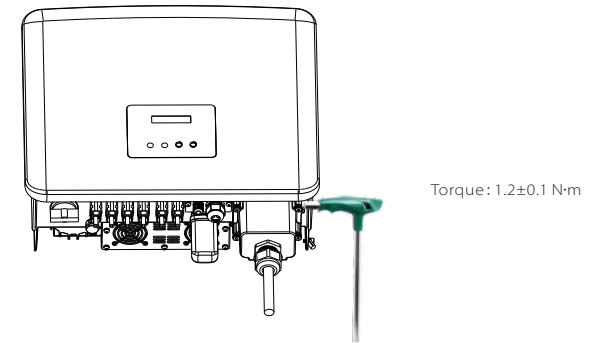

k) Tighten the waterproof fastening head.

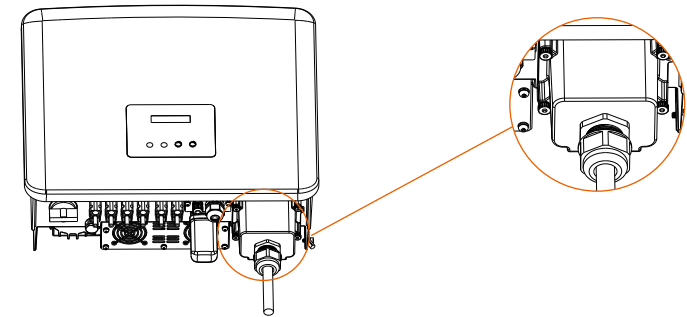

### Selection of Fuses and Cables

Mains cable (AC line cable) shall be short-circuit protected and thermal overload protected.

Always fit the input cable with fuse. Normal gG (US:CC or T) fuses will protect the input cable in short circuit situation. They will also prevent damage to adjoining equipment.

Dimension the fuses according to local safety regulations, appropriate input voltage and the related current of the solar inverter.

The rated short-circuit breaking capacity of the above protective device shall be at least equal to the prospective fault current at the point of installation. See section technical data of this manual for details.

AC output cable: Cu; L1,L2,L3, N+PE: 3\*5.0 mm<sup>2</sup>+2\*5.0 mm<sup>2</sup> for X3-PRO-8K-G2 and 3\*6.0 mm<sup>2</sup>+2\*6.0 mm<sup>2</sup> for X3-PRO-10K-G2/X3-PRO-12K-G2/X3-PRO-15K-G2 and 3\*8.0 mm<sup>2</sup>+2\*6.0 mm<sup>2</sup> for X3-PRO-17K-G2/X3-PRO-20K-G2/X3-PRO-10K-G2-LV and 3\*10.0 mm<sup>2</sup>+2\*6.0 mm<sup>2</sup> for X3-PRO-25K-G2/X3-PRO-30K-G2/X3-PRO-12K-G2-LV/X3-PRO-15K-G2-LV @40°C ambient temperature.

#### Note!



1. For condition differing from those mentioned above, dimension the cables according to local safety regulations, appropriate input voltage and the load current of the unit. (You can choose a thicker cable but the fuses must be rated according to the rating of the cable.)
2. Fuses must be approved by Notified Body.

Therefore the current-carrying capacity of the components and sub-assemblies provided in the end-use system (connectors, cables, junction box, switchgear, etc.) and the reverse current PV modules shall be considered based on the feedback current and reverse current. The direct current (DC) circuit breaker or fuse between each solar generator and inverter shall be provided based on solar inverter input ratings.

Select DC cables based on the above inverter back-feed current and ISC PV rating and Vmax ratings.

### 6.3 Earth Connection

a) Find the terminal sleeve and the R-type terminal in the accessories. Prepare a grounding cable (4 mm<sup>2</sup>).



b) Strip 7 mm insulation layer from the end and pull the terminal sleeve over the cable.

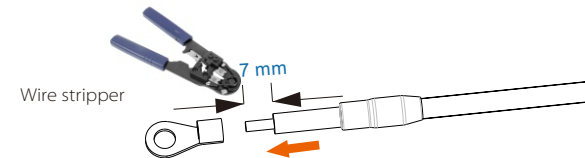

c) Insert the stripped section into the R-type terminal and crimp it.

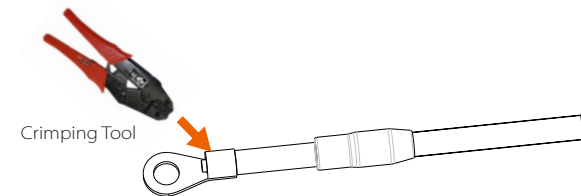

d) Pull the terminal sleeve over the crimped section of the R-type terminal and make sure it is firmly contacted with the terminal.

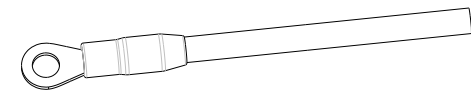

e) Tighten the ground screw with an inner hexagonal wrench as shown in the figure below. ( $\varnothing 5$  inner hexagonal screw. Torque:  $1.2 \pm 0.1$  N·m)

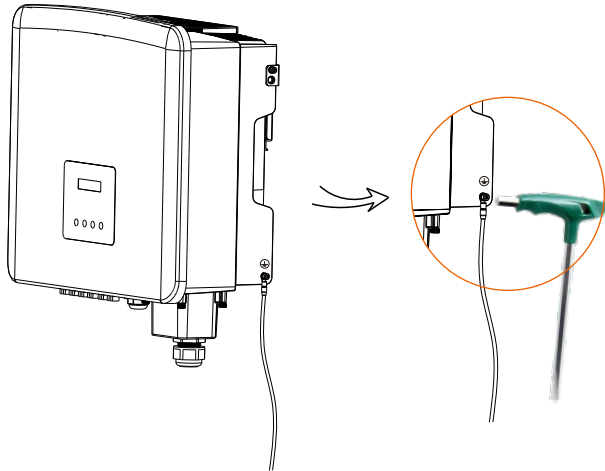

## 6.4 Communication Connection

This product has a series of communication interfaces: such as WiFi/LAN/GPRS, RS485/Meter, DRM and USB for upgrading for human and machine communication. Operating information like output voltage, current, frequency, faulty information, etc., can be delivered to PC or other monitoring equipment via these interfaces.

### 6.4.1 Monitoring Connection (Optional)

This inverter provides a monitoring dongle connecting port (the Dongle port) which can collect information from inverter including status, performance and updating information to the monitoring website via connecting WiFi/LAN/4G dongle (The monitoring dongle is optional, which can be purchased from the supplier if needed).

For example, insert the WiFi dongle into the port named "Dongle" on the bottom of the inverter.

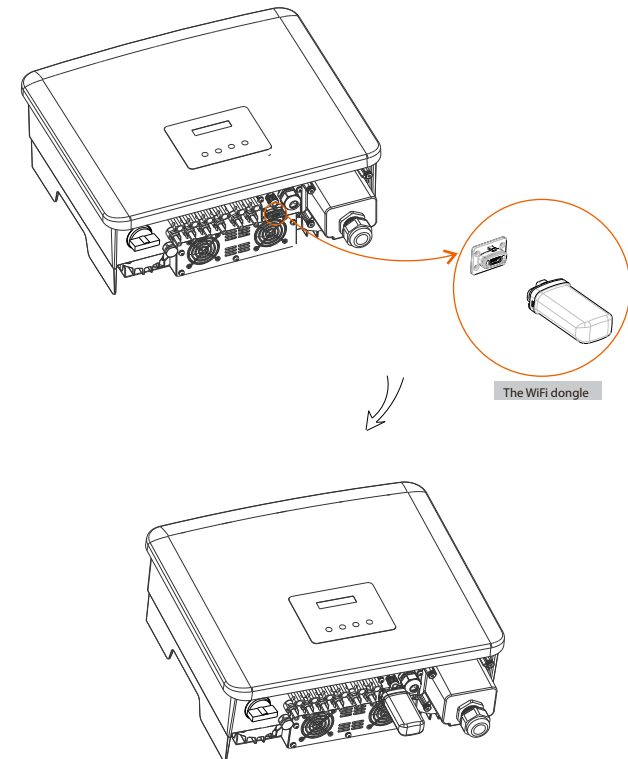

#### Connection steps:

Please check the user manual of the WiFi dongle for more details.

### 6.4.2 COM Connection

This inverter provides a COM port, through this port the inverter can achieve multiple functions like DRM(Demand Response Management), dry contact function and heat pump control via Adapter Box.

• **COM Connection Steps:**

a) Unscrew the cover on the COM port and locate the port.

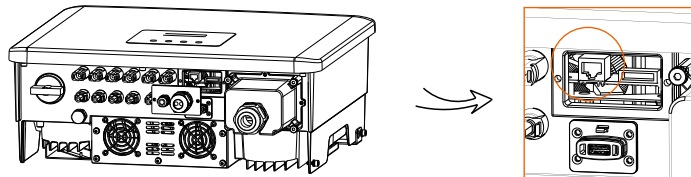

- b) Prepare RJ45 connector and a communication cable.
- c) Strip the insulation from the communication cable.
- d) Let the communication cable pass through the waterproof plug, then insert it into the RJ45 connector following the PIN definition rule.
- e) Crimp the RJ45 connector with the crimping plier.



f) Insert the cable into the COM port of the inverter, and tighten the waterproof plug.

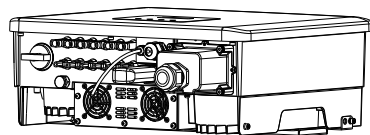

• **PIN Definitions for DRM, Dry Contact, Heat Pump Controller**

a. DRM is provided to support several demand response modes by giving control signals as below.

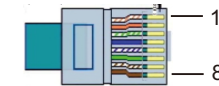

Pin	1	2	3	4	5	6	7	8
Definition	X	X	X	X	REF GEN	DRMO	X	X

b. Dry Contact is provided to control the closing and breaking of switches by giving control signals as below.

Pin	1	2	3	4	5	6	7	8
Definition	Dry Contact+	Dry Contact-	X	X	X	X	X	X

c. Heat Pump Controller is the controlling signal provide by the inverter to switch on or off the SG ready heat pump via Adapter Box. The PIN definition is as below:

Pin	1	2	3	4	5	6	7	8
Definition	X	X	Heat Pump Controller+	Heat Pump Controller-	X	X	X	X

### 6.4.3 RS485/Meter Connection

There is an RS485 port on the bottom of the inverter. Through this port, the inverter can communicate with the computer, Datahub or other devices and the meter and achieve the parallel function or EV-Charger function.

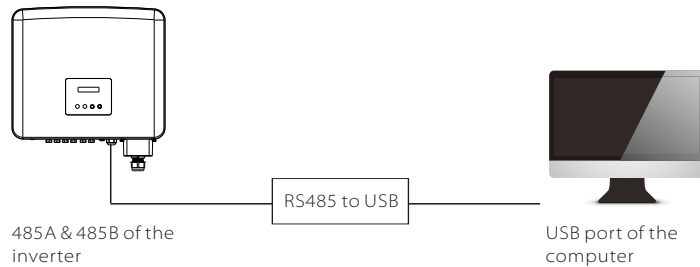

• RS485 Connection Steps:

a) Unscrew the cover on the RS485 port and locate the port.

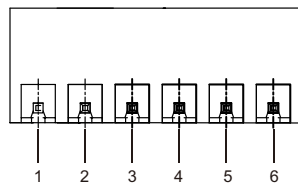
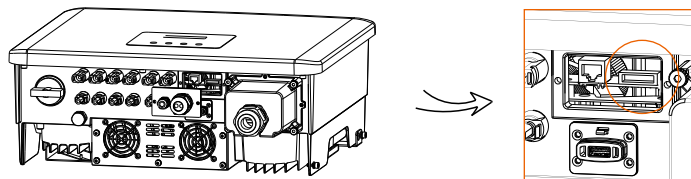

The PIN definitions of RS485 port are as below.

Pin	1	2	3	4	5	6
Definition	485A	485B	485A	485B	meter A	meter B

- b) Prepare a communication cable and strip the insulation from the cable.
- c) Let the cable pass through the waterproof plug. Then insert the wires into the corresponding pins of the terminal block following the PIN definition rules and tighten the wires.

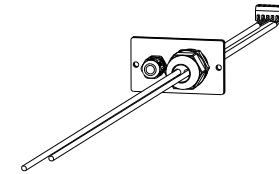

d) Insert the terminal block into the RS485 port of the inverter and tighten the waterproof plug.

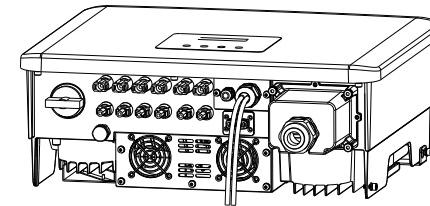

**Note!**  
 When making RS485 wiring, the wiring should be connected according to correct sequence:  
 For communication with computers: 485A-485B & 485B-485A;  
 For other devices (including inverters, Datahub, etc.): 485A-485A & 485B-485B.

### 6.4.3.1 Meter Connection (Optional)

The inverter can communicate with a meter through this interface, with the meter you can:

1. Monitor the energy to grid and from grid throughout the whole day.
2. Achieve the export control function with a higher accuracy.

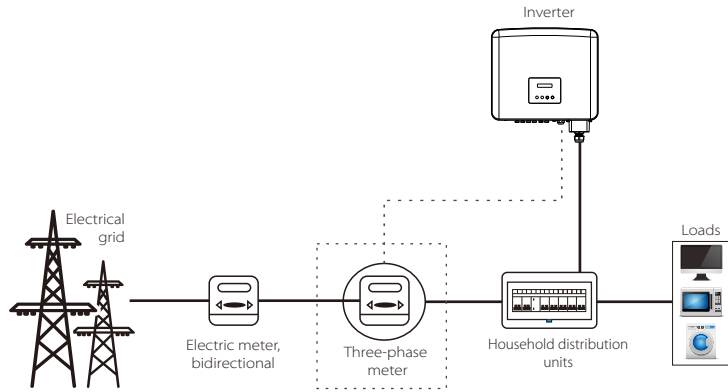

**Note!**



The smart meter must be authorized by us, any third party or non-authorized meter may not match with the inverter. We will not take the responsibility if the unauthorized meter is unavailable.

**Meter Connection Steps:**

Please see the Quick Installation Guide for three-phase meter for details.

### 6.4.3.2 Parallel Connection

The series inverter provides the parallel connection function, which could support several inverters to parallel in one system and can control zero injection to the grid with a meter installed in the main circuit.

The parallel system can be achieved with Modbus Function or with Datahub. Please refer to the following diagrams.

Diagram A: Parallel system with Modbus Function

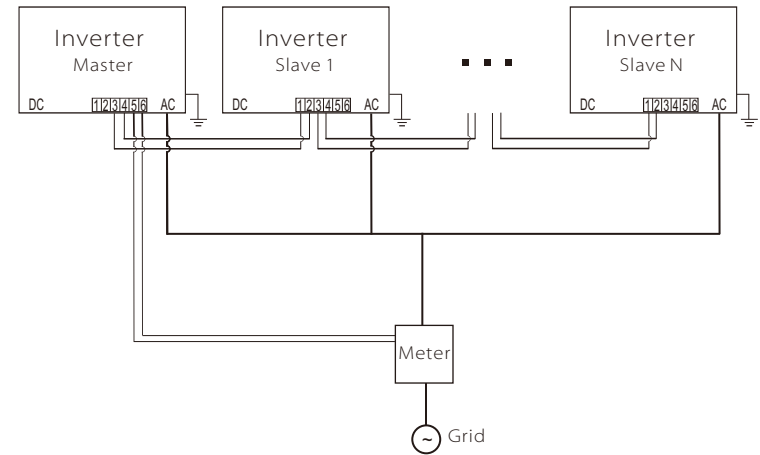
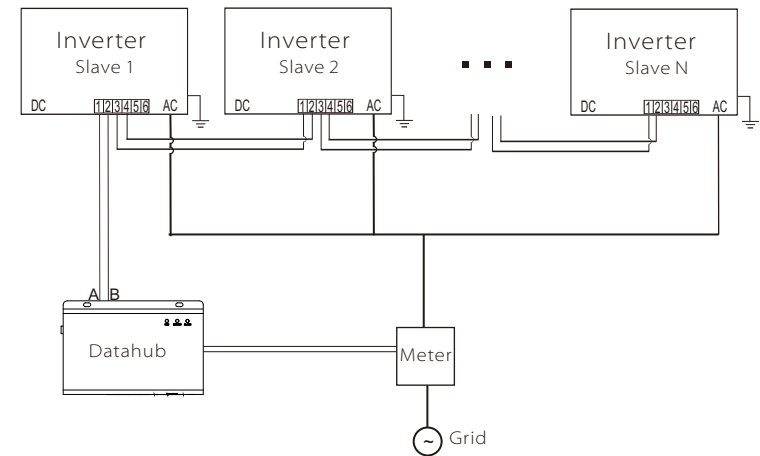

Diagram B: Parallel system with Datahub



**Note!**



Before operation, please make sure that the inverters meet the following conditions:  
 1. All the inverters are recommended to be the same series;  
 2. The firmware version of all inverters shall be the same.  
 Otherwise, the parallel function cannot be used.

➤ **Parallel system with Modbus Function**

In this parallel system, at most 5 inverters can be connected. One inverter will be set as a master, and the rest are the slaves. The master inverter can communicate with all the slave inverters.

• **Wiring operation**

- a) Connect all the inverters in the parallel system with each other via RS485 cables.
- b) Connect the communication cable of the meter with the master inverter.

• **LCD setting**

Turn on the power of the entire system, enter the "Settings" page of the inverters on the LCD screen. Follow the instructions below to complete the settings.

- a) Make sure the meter is connected to the master inverter. Enter the "Export Control" page and choose "Meter" on the master inverter.

> Export Control  
DRM Function

> Mode Select  
Meter

- b) Enter "ParallelSetting" page, choose "Enable" to activate the function for all the inverters. Please disable this function if not needed.

> ParallelSetting  
MpptScanMode

> Mode Select  
Enable

- c) Select "Master" for the master inverter and "Slave" for the slave inverters. Only one inverter can be set as "Master".

> M/S Select  
Master/Slave

- d) Set the value for "System Limit" on the master inverter. This will be the overall power limit for the parallel system. The output power of slaves will then be distributed respectively according to their nominal output power. The value can be set within the range of 0 kW to 180 kW and the default value is 180000 W.

> System Limit  
180000W

**Note!**



The power limit value set in "System Limit" is the limit for the multiple inverters in the parallel system, while the "UserValue" set in "Export Control" is the power limit for a single inverter which will be nullified when the parallel function is enabled.

**Note!**



The parallel system with Modbus Function and the EV-Charger function cannot be used at the same time currently. If the EV-Charger is connected when multiple inverters are working in the parallel system:  
 When the "ParallelSetting" is enabled, the EV-Charger will become a common load and can only charge in Fast mode, other smart charging modes will not be available.  
 When the "ParallelSetting" is disabled, the EV-Charger function is enabled, then the EV-Charger can work normally with the inverter it is connected to, while other inverters cannot realize the export control function.



➤ **Parallel system with Datahub**

In this parallel system, at most 60 inverters can be connected. The Datahub will be the master of the system, and all the inverters are the slaves. The Datahub can communicate with all the slave inverters.

**Note!**

Before connecting the Datahub to the parallel system, please check that the inverters' settings meet the following conditions:

1. The "Modbus Function" should be "**COM485**".
2. The "ParallelSetting" should be "**Disable**".
3. The addresses of all the inverters in the "RS485 CommAddr" should be **different**. Otherwise, please reset the RS485 communication addresses.

• **Wiring operation**

- a) Connect on end of an RS485 communication cable with Datahub, and the other end with one of the slave inverters.
- b) Connect all the slave inverters with each other via RS485 cables.
- c) Connect the meter with the Datahub and the mains.

**Note!**

The inverter connected with the Datahub should not enable the "ParallelSetting". There is no need to set the "ParallelSetting" on the inverters, the parallel system with Datahub will start automatically.

For the details, please refer to the user manual of Datahub.

**6.4.3.3 EV-Charger Function**

The inverter can communicate with the smart EV-Charger to form an intelligent photovoltaic, storage and EV charging energy system, thus maximizing the utilization of photovoltaic energy.

Diagram: Intelligent Photovoltaic, Storage and EV Charging Energy System

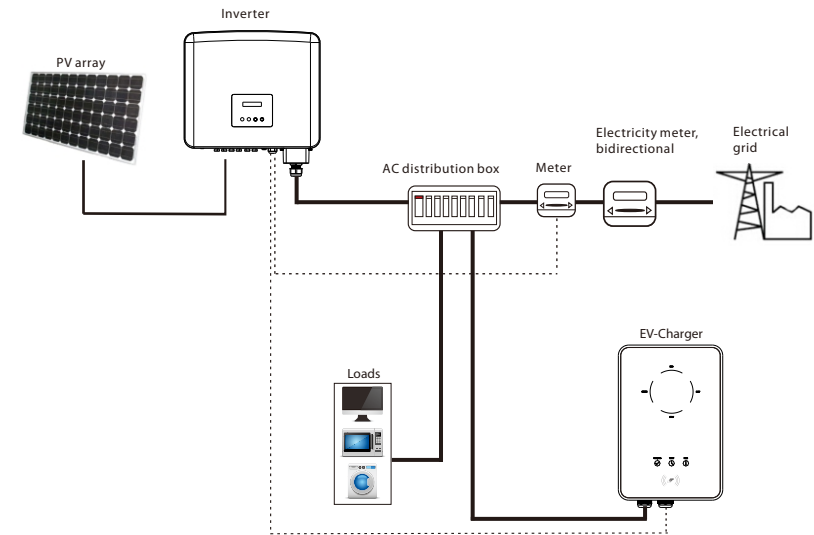

• **Wiring operation**

- a) Plug one end of the communication cable to the right pin of the EV-Charger and the other end to PIN 1 & 2 or 3 & 4 of the "RS485" port of the series inverter.
- b) Connect the meter to PIN 5 & 6 of the "RS485" port of the inverter.

• **LCD setting**

Turn on the power of the entire system, enter the "Settings" page of the inverters on the LCD screen.

- a) Enter the "Export Control" page and choose "Meter".

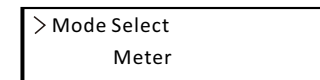
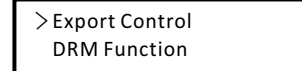

b) Enter “Modbus Fuction” and select “EV Charger”.

> Modbus Function

> Function Select  
EV Charger

c) Set the “Grid Data Source” as “Inverter” in the APP of the EV-Charger.

For the installation and settings of the EV-Charger, please refer to the user manual of the EV-Charger for details.

#### Note!



The EV-Charger function and the parallel system with Datahub or the parallel system with Modbus Function cannot be used at the same time currently.

#### 6.4.3.4 Special Notice

The three functions (i.e. Parallel system with Modbus Function, Parallel system with Datahub and EV-Charger function) conflict with each other due to sharing the same RS485 port and only one of the three functions can be used at a time.

If the three functions are enabled at the same time accidentally, please follow the instructions below:

1. If the “ParallelSetting” is enabled and the inverter is the master one while the system is connected with Datahub, please remove the Datahub then the parallel system will work normally. If the Datahub is to be remained in the parallel system, remove the Datahub first and disable the “ParallelSetting”, then reconnect the Datahub.
2. The parallel system and the EV-Charger function cannot be enabled at the same time. Once the EV-Charger function is enabled, remove the external RS485 wiring or connect it to the EV-Charger if the external RS485 is connected with another inverter.
3. If the EV-Charger function is enabled and Datahub is connected in the system, please remove the Datahub, then the EV-Charger will work normally. If the Datahub is to be remained in the parallel system, remove the Datahub first and change “EV Charger” to “COM485” under the “Modbus Fuction”, then reconnect the Datahub.

### 6.4.4 Upgrade

The inverter system can be updated through an U-disk.



**Warning!**

Make sure the input voltage is more than **200 V** (in good illumination condition), or it may result in failing during updating.

**Upgrade Steps:**

1) Please contact our service support to get the update file, and extract it into your U-disk as the following file path:

```
"update\ARM\618.xxxx.00_XXXXXXXX_ARM_Vx.xx_xxxxxxx.usb";
"update\DSP\618.xxxx.00_XXXXXXXX_DSP_Vx.xx_xxxxxxx.usb".
```

Note: Vx.xx is version number, xxxxxxxx is file completion dates.



**Warning!**

Make sure the directory is in accordance with above form strictly! Do not modify the program file name! Or it may cause the inverter to stop working!

2) Make sure the DC switch is off and the AC is disconnected with grid. If the WiFi dongle is connected to the port, please remove the WiFi dongle at first.

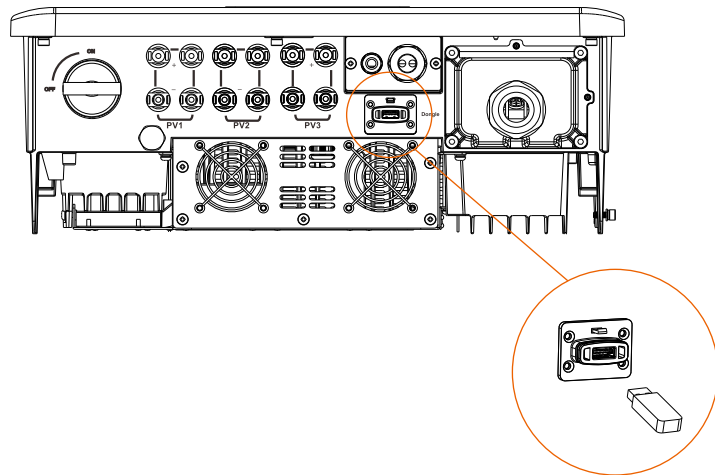

3) Then insert the U-disk into the Dongle port on the bottom of the inverter. Then turn on DC switch and connect the PV connector, the LCD will show a picture as below.

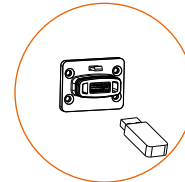

===== Update =====

> ARM  
DSP

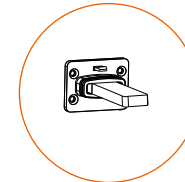

4) Press the "Up" and "Down" button to select ARM or DSP. Then long press "Down" and select the correct update file to confirm the update. ARM and DSP shall be updated one by one.

5) After the upgrade is completed, please remember to turn off the DC switch or disconnect the PV connector, then pull off the U-disk, and connect the WiFi dongle back.



**Warning!**

During updating, don't turn off the DC switch or disconnect the PV connector. If the updating stopped due to PV power failure, do not unplug the U-disk. When the PV power recovers, the update will continue. If the updating stopped due to other reasons, reinsert the U-disk to continue the update.

### 6.5 Run the inverter

Start inverter after checking all below steps:

- Check that device is fixed well on the wall.
- Make sure all the DC breakers and AC breakers are OFF.
- AC cable is connected to grid correctly.
- All PV panels are connected to inverter correctly, DC connectors which are not used should be sealed with a lid.

#### Start inverter

- Turn on the external AC and DC switches.
- Turn on the DC switch to the "ON" position.
- Inverter will start automatically when PV panels generate enough energy.
- Check the status of LED indicators and LCD screen, the LED indicators should be blue and the LCD screen should display the main interface.
- If the LED indicator is not blue, please check the below:
  - All the connections are correct.
  - All the external disconnect switches are closed.
  - The DC switch of the inverter is in the "ON" position.

Below is the three different states when operating, which means inverter starting up successfully.

**Warning:** Inverter is waiting to checking when DC input voltage from panels is greater than 160V (lowest start-up voltage) but less than 200V (lowest operating voltage).

**Checking:** Inverter will check DC input environment automatically when DC input voltage from the PV panels exceeds 200V and PV panels have enough energy to start inverter.

**Normal:** Inverter begins to operate normally with blue light on, meanwhile the inverter feeds back energy to the grid and the LCD displays current output power. Enter the setting interface to follow the instructions when it is first time to start up.



**Warning!**  
Power to the unit must be turned on only after installation work has been completed. All electrical connections must be carried out by qualified personnel in accordance with legislation in force in the country concerned.



**Note!**  
Please set the inverter if it is the first time to start up. Above steps are for the regular start of the inverter. If it is the first time to start up the inverter, you need to configure the settings for the inverter after start up.

## 7 Operation Method

### 7.1 Control Panel

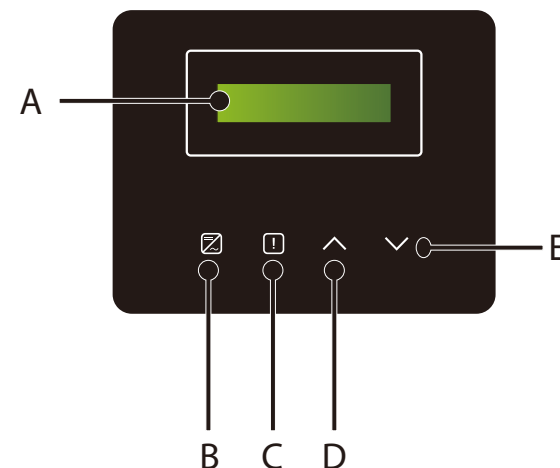

Object	Name	Description
A	LCD Screen	Display the information of the inverter.
B	LED Indicator	Light in blue: The inverter is in normal status.
C		Flash in blue: The inverter is in waiting status.
D	Function Button	Up/Back button: Move cursor to upside or increase value. Return from current interface or function.
E		Down/Enter button: Move cursor to downside or decrease value. Confirm the selection.

Note:

Key	Operation	Description
^ Up/Back	Long Press	Return to the previous menu or confirm function setting
	Short Press	Look at the previous parameter or increase the value
v Down/Enter	Long Press	Go to the next menu or confirm value change
	Short Press	Look at the next parameter or decrease the value

### 7.2 LCD Function & Operation

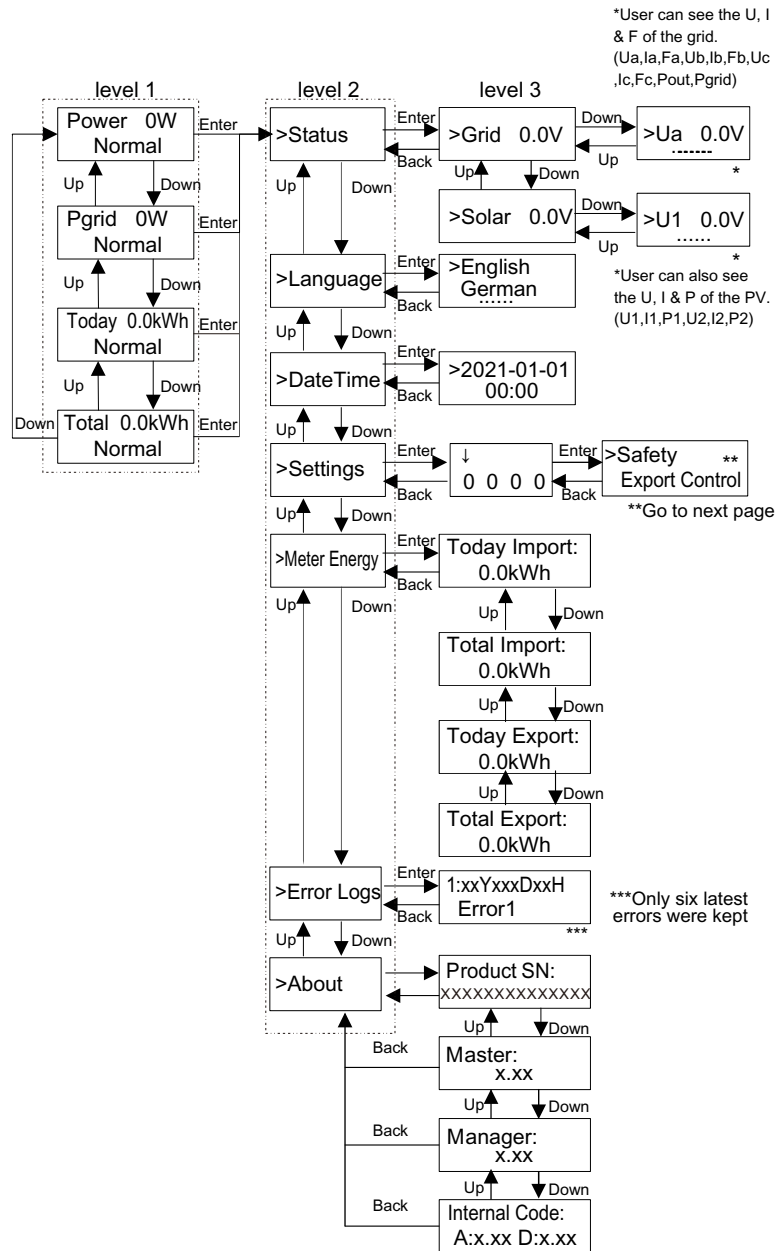

### Settings page

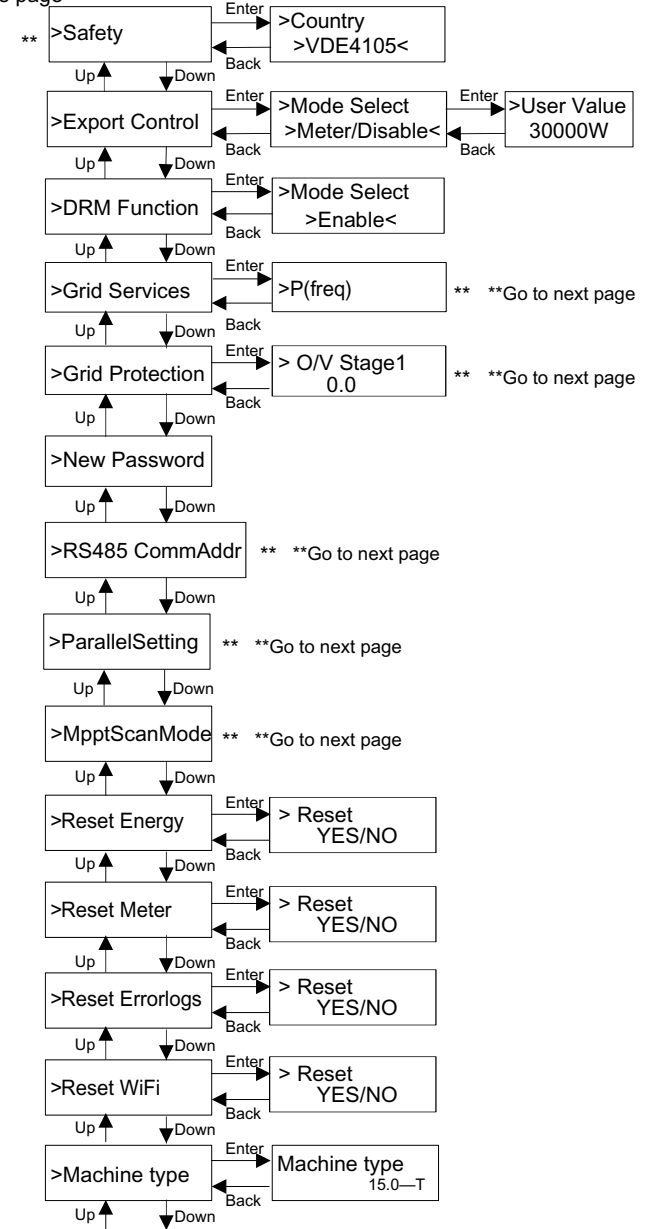

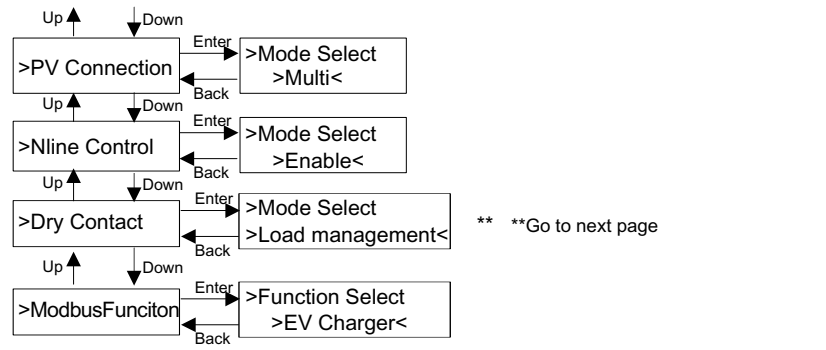

Grid Services and Grid Protection page

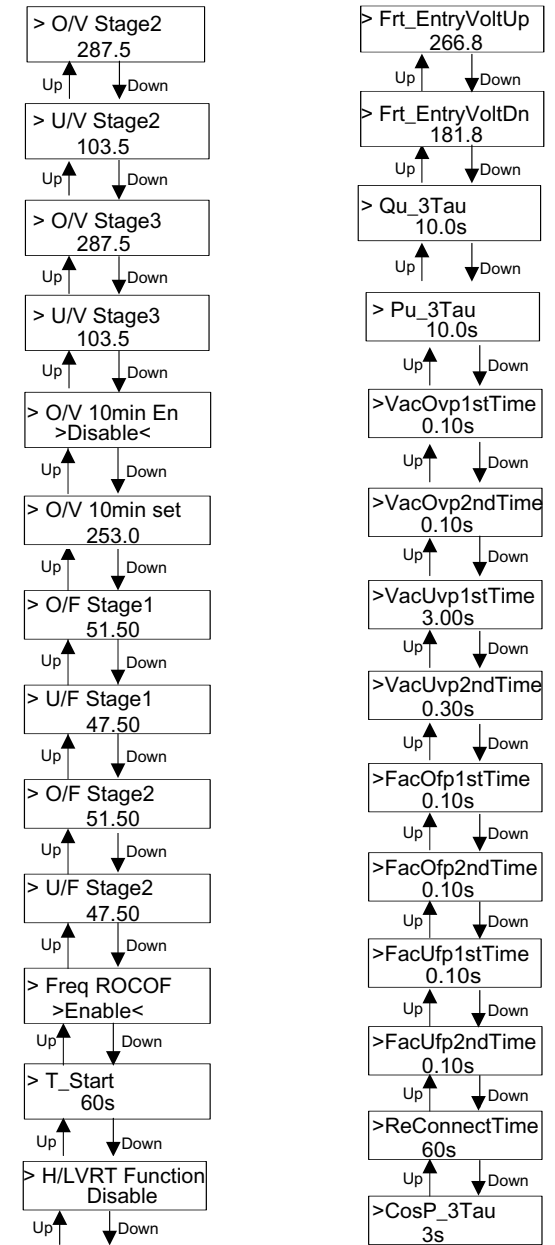
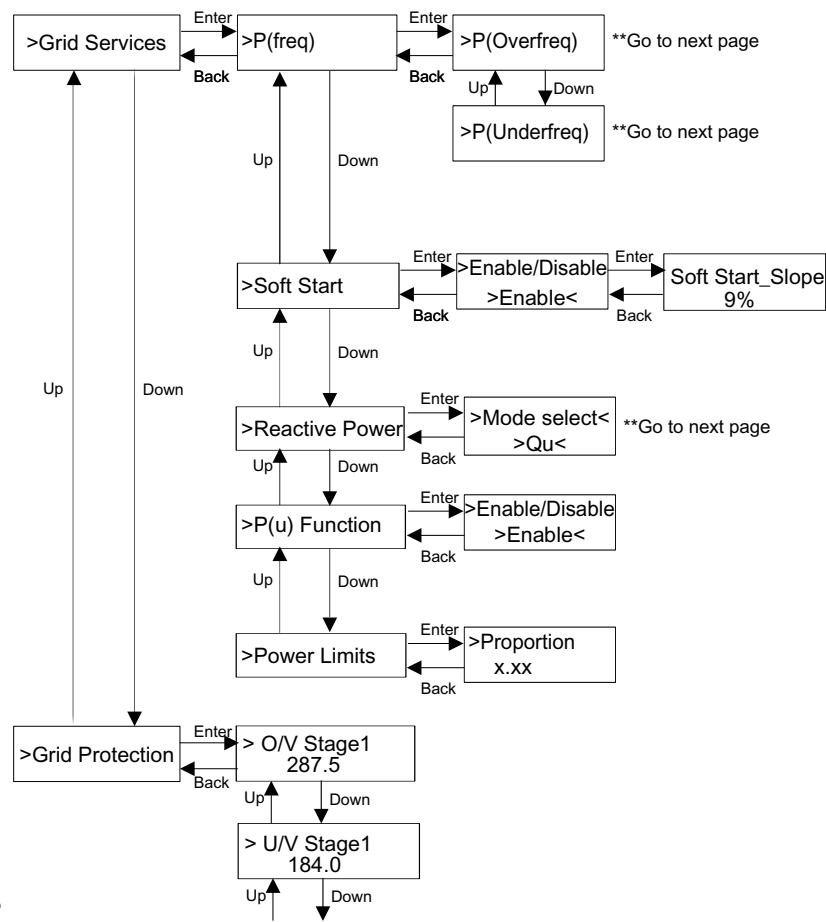

➤ LCD Digital Display

The main interface (Level 1) is the default interface, the inverter will automatically jump to this interface when the system started up successfully or not operated for a period of time.

The interface shows the following information. "Power" means the timely output power; "Pgrid" means the power export to or import from the grid; (Positive value means the energy feeds into the grid, negative value means the energy used from the grid); "Today" means the power generated within the day; "Total" means the power generated until now.

Press "Up" and "Down" to review the information.

Power	0W
Normal	

➤ Menu interface

The menu interface (Level 2) is a transfer interface for the user to get into other interface to finish the setting or get the information.

-User can get into this interface by long pressing "Down" button when LCD displays the main interface.

-User can select by moving the cursor with function button, and long press "Down" to confirm.

= = = = Menu = = = =

> Status
Language

• Status

The status function contains two aspects, the grid and the solar.

Press "Up" and "Down" to select and long press "down" to confirm the selection, long press "Up" to return to Menu.

= = = = Status = = = =

> Grid
Solar

a) Grid

This status shows the current condition of the AC output port of the inverter, such as voltage, current, output power and grid power. "Pout" measures the output of the inverter, "Pgrid" measures power export to or import from the grid. Positive value means the power feeds into the grid, negative value means the power used from the grid.

Press "Up" and "Down" button to review the parameter, long press "up" to return to Status .

= = = = Grid = = = =

> Ua	0.0V
Ia	0.0A

\*

b) Solar

This status shows the real time PV condition of the system, such as input voltage, current and power situation of each PV input.

Press "Up" and "Down" button to review parameter, long Press "Up" to return to Status.

= = = = Solar = = = =

U1	0.0V
I 1	0.0A

\*

• Language

The function refers to select a language from English, German, Polish, French, Portuguese, etc.

= = = = Language = = = =

> English
German

• Date Time

This interface is for the user to set the system date and time. Increase or decrease the word by pressing "Up" or "Down" button. Press "Down" to confirm and alternate to next word. After all the words are confirmed. Long press "Down" to enter the date and time.

= = = = Date Time = = = =

>2021- 01 -01
00:00

• Settings

Setting function is used for setting the inverter for safety, connection, Grid and so on.

\* Password

The default password is "2014" for the installer, which only allows the installer to review and modify necessary settings complying to the local rules and regulations. If further advanced setting is required, please contact the distributor or us for assistance. We need to increase or decrease the word by pressing up or down button. Press "Down" to confirm an alternate to the next word. After word is confirmed, long press "Down" to enter password.

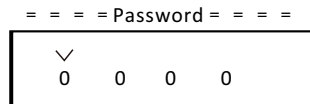

When inputting the password, the information of the LCD interface is shown as below.

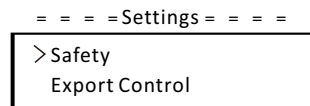

a) Safety

The user can set the safety standard here according to different countries and grid tied standards. There are several standards for choice (May change without notice). In addition, the user has an "UserDefined" option which allows the user to customize relevant parameters within a wider range.

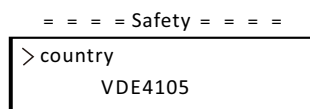

b) Export Control

With this function the inverter can control energy exported to the grid. Whether having this function is based on user's wishes.

Choose "Meter" in "Meter/Disable" means user must install a meter to monitor energy exported to the grid. There are user value and factory value. The factory value is default which can not be changed by user. The user value set by installer must be less than the factory value and within the range of 0 kW to 30 kW.

Choose "Disable" means the function will be shut off.

Press "Up" and "Down" button to select and long press "Down" to confirm.

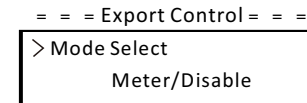

c) DRM Function

Installer can choose "Enable" to control the inverter's power off through the external communication.

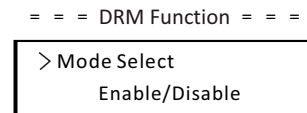

d) Grid Services

Usually end user do not need to set the grid parameters. All default value have been set before leaving factory according to safety rules.

If reset is needed, any changes should be made according to the requirements of local grid.

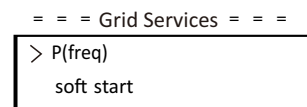

\*  
\*



1. = = = P(freq) = = =  
 If reset is needed, any changes should be made according to the requirements of local grid.

> P(Overfreq)  
 P(Underfreq)

2. = = = Soft Start = = =  
 If reset is needed, any changes should be made according to the requirements of local grid.

> Enable/Disable  
 >Disable <

3. Soft Start\_Slope  
 If set as shown, 9 percent of the rated power increase per minute.

9%

4-1. = = = Reactive Power = = =  
 If reset is needed, any changes should be made according to the requirements of local grid.

> Mode Select  
 >Off <

Mode Select	Comment
Off	-
Over-Excited	PF value
Under-Excited	PF value
PF(P)	PowerFactor1(2/3/4)
	PowerRatio1(2/3/4)
	EntryVolt
	ExitVolt
Q(u)	Q(u) PowerLockEn
	Q(u) LockIn
	Q(u) LockOut
	Q(u) GridV1/V2/V3/V4
Fix Q Power	Q Power

4-2. Reactive power control, Reactive standard curve  $\cos \varphi = f(P)$

For VDE ARN 4105, curve  $\cos \varphi = f(P)$  should refer to curve A. Default values of setting are as shown in curve A.  
 For E 8001, curve  $\cos \varphi = f(P)$  should refer to curve B. Default values of setting are as shown in curve B.

Reactive power control, Reactive standard curve  $Q = f(V)$

$V2s = 1.10V_n$   
 $V1s = 1.08V_n = Q_u \text{VlowRate}$   
 $V2i = 0.90V_n$   
 $V2i = 0.92V_n = Q_u \text{VlowRate}$

5. = = = P(u) Function = = =

> Enable/Disable  
 >Enable <

Enter → 

> Vw1  
242

 ← Back

This function can limit the power. There are several values to be set.

6. = = = Power Limits = = =  
 User can set the power limit here, the setting value is between 0.00 and 1.00.

> Proportion  
 0.40

e) Grid Protection

Usually end user do not need to set the grid Protection. All default value have been set before leaving factory according to safety rules. If reset is needed, any changes should be made according to the requirements of local grid.

```

= = = Grid Protection = = =
> O/V Stage1
    0.0
    
```

f) New Password

The user can set the new password here. We need to increase or decrease the word by pressing "Up" or "Down" button. Long press "Down" to confirm and alternate to next word. After word is confirmed, long press "Down" to reset the password.

```

= = = New Password = = =
1  2  3  4
           √
    
```

g) RS485 CommAddr

If "Enable" is selected, the inverter will communicate with the computer, through which the operating status of the inverter can be monitored. When multiple inverters are monitored by one computer, RS485 communication addresses of different inverters need to be set. The default address is "1".

```

= = = RS485 CommAddr = = =
> Set Address
    1
    
```

h) ParallelSetting

When the user wants to use the parallel system with Modbus Function, enable this function and complete the settings following the instructions in section "Parallel Connection". If not needed, disable this function.

```

= = = ParallelSetting = = =
> Mode Select
    Disable
    
```

i) Mppt Scan Mode

There are four modes to be selected. "Off", "LowFreqScan", "MidFreqScan", "High FreqScan". It shows the frequency of PV panel scan. If "LowFreqScan" is selected, the inverter will scan the PV panel by low frequency.

```

= = = Mppt Scan Mode = = =
> Mode Select
    >Off<
    
```

j) Reset Energy

The user can clear the power energy by this function.

```

= = = Reset Energy = = =
> Mode Select
    >YES/NO<
    
```

k) Reset Meter

The user can clear the meter energy by this function. Press "Up" or "Down" button to select and long press "Down" to confirm. (The user can select "Yes" to reset meter if the user uses meter)

```

= = = Reset Meter = = =
> Reset
    >YES/NO<
    
```

l) Reset Errorlog

The user can clear the errorlogs by this function. Press "Up" or "Down" button to select and long press "Down" to confirm.

```

= = = Reset Errorlog = = =
> Reset
    >YES/NO<
    
```

m) Reset WiFi

The user can restart the WiFi by this function.

```

= = = Reset WiFi = = =
> Reset
    >YES/NO<
    
```

n) Machine Type

The user can check the Machine Type by this function.

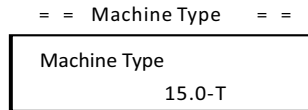

o) PV Connection

The user can select the PV connection type by this function.

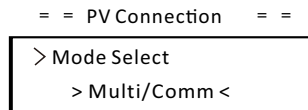

p) Nline Control

The user can enable or disable the Nline Control by this function.

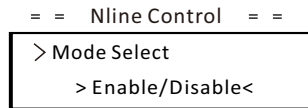

q) Dry Contact

The user can use the Dry Contact to connect SG Ready heat pump by this function via Adapter Box.



There are three functions(Disable/Manual/Smart Save) which can be selected for Load Management. **“Disable”** means the heat pump is off. When **“Manual”** is selected the user can control the external relay to remain close or open manually. **“Smart Save”** mode can set the values of the heat pump’s on/off time and conditions, operating modes.

If the user uses the inverter dry contacts to control heat pump through Adapter box, please refer to the Adapter Box Quick Installation Guide to set the parameters here.

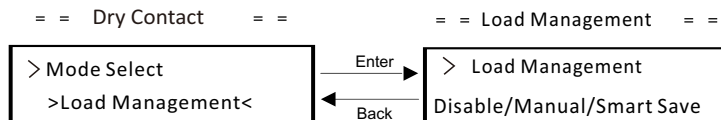

r) Modbus Function

Select “EV Charger” for communication with the EV-Charger, select “COM485” for communication with other devices.

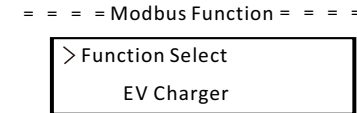

• Meter Energy

The user can check the import and export energy by this function. There are four parameters: “Today Import”, “Total Import”, “Today Export”, “Total Export”. Press “Up” and “Down” to review the values.

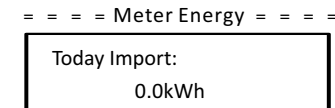

• Error Logs

The Error log contains error information happened. It can record six items at most. Press “Up” and “Down” button to review parameter. Long press “Up” to return to the main interface.

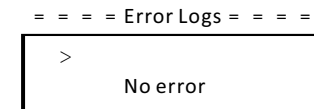

• About

This interface shows information of the inverter, include “Product SN”, “Master”, “Manager” and “Internal Code”.

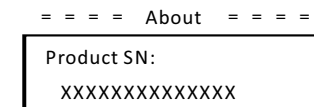

## 8 Troubleshooting

### 8.1 Troubleshooting

This section contains information and procedures for solving possible problems with the series inverters, and provides you with troubleshooting tips to identify and solve most problems that could occur with the series inverters.

This section will help you narrow down the source of any problems you may encounter. Please read the following troubleshooting steps.

Check warnings or fault messages on System Control Panel or Fault codes on the inverter information panel. If a message is displayed, record it before doing anything further.

Attempt the solution indicated in below table.

Faults	Diagnosis and Solution
TzFault	Over Current Fault. -Wait for about 10 seconds to check if the inverter is back to normal. -Disconnect the DC switch and restart the inverter. -Or seek help from us.
GridLostFault	Grid Lost Fault. -Check if the mains cable is loose. -Wait for a while and the system will reconnect when the utility is back to normal. -Or seek help from us.
GridVoltFault	Grid Voltage Out of Range. -Check if the mains cable is loose. -Wait for a while and the system will reconnect when the utility is back to normal. -Or seek help from us.
GridFreqFault	Grid Frequency Out of Range. -Wait for a while and the system will reconnect when the utility is back to normal. -Or seek help from us.
PVoltFault	PV Voltage Fault. -Check whether the PV is overvoltage. -Or seek help from us.
BusVoltFault	DC Bus Voltage Out of Normal Range. -Check if the PV input voltage is within the operating range of the inverter. -Disconnect PV wiring and reconnect. -Or seek help from us.

Faults	Diagnosis and Solution
GridVolt10MFault	Grid Overvoltage for Ten Minutes Fault. -The system will reconnect when the utility is back to normal. -Or seek help from us.
DclnjOCP	DCI Overcurrent Protection Fault. -Wait for a while to check if the inverter is back to normal. -Or seek help from us.
HardLimitFault	Hard Limit Fault (in Australian standard). -Wait for a while to check if the inverter is back to normal. -Or seek help from us.
SW OCP Fault	Software Overcurrent Protection Fault. -Wait for a while to check if the inverter is back to normal. -Disconnect PV and grid, then reconnect. -Or seek help from us.
ResidualOCP	Overcurrent Protection Fault. -Check the connections of the inverter. -Wait for a while to check if the inverter is back to normal. -Or seek help from us.
IsoFault	Isolation Fault. -Check the connections of the inverter. -Or seek help from us.
OverTempFault	Over Temperature Fault. -Check if the inverter and the ambient temperature exceeds the operating range. -Or seek help from us.
LowTempFault	Low Temperature Fault. -Check if the ambient temperature is too low. -Or seek help from us.
InternalComFault	Internal Communication Fault. -Restart the inverter to check if it is back to normal. -Update the ARM software or reburn the program. -Or seek help from us.
FanFault	Fan Fault. -Check whether the fan is faulty or damaged. -Or seek help from us.
AcTerminalOTP	AC Terminal Overtemperature Fault. -Check if the AC terminals are tightly connected. -Check if the ambient temperature exceeds the operating range. -Or seek help from us.

Faults	Diagnosis and Solution
EepromFault	DSP EEPROM Fault. -Disconnect PV wiring and reconnect. -Or seek help from us.
RcDeviceFault	Residual Current Device Fault. -Restart the inverter. -Update the ARM software or reburn the program. -Or seek help from us.
PvConnDirFault	PV Direction Fault. -Check if the PV+/- sides are connected correctly. -Or seek help from us.
GridRelayFault	Relay Fault. -Check the grid connection. -Restart the inverter. -Or seek help from us.
OtherDeviceFault	Model Incorrectly Set Fault. -Seek help from us.
Mgr EEPROM Fault	ARM EEPROM Fault. -Disconnect PV and grid, then reconnect. -Or seek help from us.
Meter Fault	Meter Fault. -Check the connection of the meter. -Check if the meter is in working order. -Or seek help from us.
Fan1 Warning	External Fan 1 Abnormal Warning. -Check if the fan is working. -Or seek help from us.
Fan2 Warning	External Fan 2 Abnormal Warning. -Check if the fan is working. -Or seek help from us.
PowerTypeFault	Power Type Fault. -Check the version of ARM and DSP. -Check the product SN number. -Or seek help from us.

● If the information panel of your inverter does not show the Fault light, check the following list to make sure that the present state of the installation allows proper operation of the unit.

- Is the inverter located in a clean, dry, adequately ventilated place?
- Have the DC input breakers been opened?
- Are the specification and length of the cables suitable?
- Are the input and output connections and wiring in good condition?
- Are the configuration settings correct for your particular installation?
- Are the display panel and the communications cable properly connected and undamaged?

Contact our Customer Service for further assistance. Please be prepared to describe details of your system installation and provide model and serial number of the unit.

## 8.2 Routine Maintenance

Regular safety check and maintenance are required.

### ► Safety checks

Safety checks should be performed at least every 12 months by manufacturer's qualified person who has adequate training, knowledge, and practical experience to perform these tests. The data should be recorded in an equipment log. If the device is not functioning properly or fails any of test, the device has to be repaired. For safety check details, refer to this manual, section 2 Safety instruction and EC Directives.

### ► Maintain periodically

Only qualified personnel may perform the following works. During the process of using the inverter, the manage person shall examine and maintain the machine regularly. The concrete operations are as follows.

- 1: Check that if the cooling fins on the rear of the inverter are covered by dirt, and the machine should be cleaned and absorbed dust when necessary. This work shall be performed from time to time.
- 2: Check that if the indicators of the inverter are in normal state, check if the keys of the inverter are in normal state, check if the display of the inverter is normal. This check should be performed at least every 6 months.
- 3: Check that if the input and output wires are damaged or aged. This check should be performed at least every 6 months.
- 4: Clean the inverter panels and check their security. This should be carried out at least every 6 months.

## 9 Decommissioning

### 9.1 Dismantling the Inverter

- Disconnect the inverter from DC Input and AC output.
- Wait for at least 5 minutes for de-energizing.
- Disconnect communication and optional connection wirings.
- Remove the inverter from the bracket.
- Remove the bracket if necessary.

### 9.2 Packaging

If possible, please pack the inverter with the original packaging.

If it is no longer available, you can also use an equivalent carton that meets the following requirements.

- Suitable for loads more than 30 kg.
- With handle.
- Can be fully closed.

### 9.3 Storage and Transportation

Store the inverter in dry place where ambient temperatures are always between -30°C - +60°C. Take care of the inverter during the storage and transportation, keep less than 4 cartons in one stack.

### 9.4 Waste Disposal

When the inverter or other related components need to be disposed, have it carried out according to local waste handling regulations. Please be sure to deliver wasted inverters and packing materials to certain site where can assist relevant department to dispose and recycle.

## 10 Disclaimer

The inverters shall be transported, used and operated under restricted conditions. We will not provide any service, technical support or compensation in case of the following circumstances, including but not limited to:

- The inverter is damaged by force majeure (such as earthquake, flooding, thunderstorm, lighting, fire hazard, volcanic eruption, etc.);
  - The inverter's warranty is expired, but not extended;
  - The inverter's SN, warranty card or invoice cannot be provided;
  - The inverter is damaged by man-made cause;
  - The inverter is used or operated against any items in local policy;
  - The installation, configuration and commissioning of the inverter doesn't meet the requirements mentioned in this manual;
  - The inverter is installed, refitted or operated in improper ways;
  - The inverter is installed, operated under improper environment or electrical condition;
  - The inverter is changed, updated or disassembled on hardware or software without authority from us;
  - The communication protocol from other illegal channels is used; and
  - The monitoring or control system is used without authority from us.
- SolaX reserves the right for the final explanation.

# Warranty Registration Form



## For Customer (Compulsory)

Name ..... Country .....

Phone Number ..... Email .....

Address .....

State ..... Zip Code .....

Product Serial Number .....

Date of Commissioning .....

Installation Company Name .....

Installer Name ..... Electrician License No. ....

## For Installer

### Module ( If Any )

Module Brand .....

Module Size(W) .....

Number of String ..... Number of Panel Per String .....

### Battery ( If Any )

Battery Type .....

Brand .....

Number of Battery Attached .....

Date of Delivery ..... Signature .....

Please visit our warranty website: <https://www.solaxcloud.com/#/warranty> to complete the online warranty registration or use your mobile phone to scan the QR code to register.

For more detailed warranty terms, please visit SolaX official website: [www.solaxpower.com](http://www.solaxpower.com) to check it.





PLEASE REGISTER THE WARRANTY IMMEDIATELY AFTER INSTALLATION!  
GET YOUR WARRANTY CERTIFICATE FROM SOLAX!  
KEEP YOUR INVERTER ONLINE & WIN SOLAX POINTS!

1

Open your camera app and point your device at the QR code



2

Wait for the camera to recognize the QR code



3

Click banner or notification when it appears on the screen



4

Warranty registration page will be loaded automatically

